



Environmental Risk Assessment

SRB Technologies (Canada) Inc.

Revision C

April 2026

Environmental Risk Assessment

SRB Technologies (Canada) Inc.

Revision C – April 2026

Report written by:	 _____	APRIL 10/2026 _____
	Jamie MacDonald Manager – Health Physics and Regulatory Affairs SRB Technologies	Date
Report reviewed by:	 _____	April 10, 2026 _____
	Katie Levesque Executive Assistant – SRB Technologies	Date
Report reviewed by:	 _____	April 10, 2026 _____
	Joshua Bull Assistant Manager – Health Physics	Date
Report accepted by:	 _____	April 10/26 _____
	Ross Fitzpatrick Vice President – SRB Technologies	Date
Report accepted by:	 _____	APRIL 10/26 _____
	Stephane Levesque President – SRB Technologies	Date

Revision History

RELEASE DATE	REVIEWED BY	REVISION NOTES
December 21, 2020	R. Fitzpatrick K. Levesque S. Levesque J. MacDonald N. Morris	Revision A – initial version of SRBT Environmental Risk Assessment (ERA) report. Report compiled to fully document the completion of an Environmental Risk Assessment of the current environment of the SRBT facility, in accordance with CSA standard N288.6-12, <i>Environmental risk assessments at Class I nuclear facilities and uranium mines and mills</i> .
April 12, 2021	R. Fitzpatrick K. Levesque S. Levesque J. MacDonald N. Morris	Revision B – revised to address CNSC review comments contained in letter from L. Posada (CNSC) to S. Levesque (SRBT), dated March 12, 2021.
April 10, 2026	J. Bull R. Fitzpatrick K. Levesque S. Levesque J. MacDonald	Revision C. Revision stemming from completion of five-year review, as per requirements of CSA N288.6.

EXECUTIVE SUMMARY

SRB Technologies (Canada) Inc. (SRBT) is the world's leading producer of gaseous tritium light sources (GTLS) – flame-sealed borosilicate glass capsules, internally coated with a phosphorescent powder, and vacuum back-filled with elemental tritium gas.

The low-energy beta particles emitted during the decay of the tritium gas interact with the phosphorescent powder and produce visible light. These light sources are installed into various devices that require a reliable light source without electrical power or other external power source.

As required by the Licence Conditions Handbook associated with our operating licence, SRBT is required to document and maintain an Environmental Risk Assessment (ERA), in accordance with Canadian Standards Association (CSA) standard N288.6-12 (R2017), *Environmental risk assessments at Class I nuclear facilities and uranium mines and mills*.

The purpose of this type of assessment is to identify the contaminants and physical stressors of concern potentially associated with routine facility operations, to develop a model representing the various means of exposure of human and ecological receptors to the specified stressors, to assess the level of exposure to these stressors, and to compare the exposure levels to reasonable benchmark values in order to assess the risk to those receptors.

The ERA represents an important component of the licensing basis of the SRBT facility. It is intended to be the foundational risk assessment document describing the level of impact posed by daily operations of the facility to members of the public and non-human organisms in the environment in the area nearby.

This assessment provides a key informative base for the design of the monitoring programs implemented as part of SRBT's Environmental Management System (EMS). Data from decades of environmental monitoring in the area around the facility has been used as a key input into the assessment, and the results of the assessment will help to inform adjustments to these programs going forth, in a spirit of continuous improvement.

The ERA is divided into two key parts – a human health risk assessment (HHRA) and an ecological risk assessment (EcoRA).

For the HHRA, several groups of critical receptors are defined and described, representing the most-impacted groups of persons, including receptors of a nearby Indigenous community. Should the derived risk to these individuals be shown to be

acceptably low, then the risks to all other persons can also be concluded to be acceptably low, as the risk to critical receptors bounds the rest of the population.

Similarly, valued ecosystem components (VEC) are selected as part of the EcoRA, which are again intended to present the limiting case for all organisms possibly affected by facility operations. Where there is an absence of field data, assumptions on each organism's key characteristics are conservatively selected, in order to provide confidence and reduce uncertainty in the assessment of risk to any given organism or population in the area around the facility.

The concentration of contaminants of potential concern (COPC) in the environment surrounding the facility is either taken from measurements from SRBT's Environmental Monitoring Program (EMP) and focused special sampling campaigns, or a hypothetical and conservative concentration is applied, with confidence that the actual concentration experienced by receptors is very likely to be lower.

Using guidance from CSA standard N288.6-12, as well as recommended factors for both ecological organisms and humans taken from (or derived from) CSA standard N288.1-14 (R2019), *Guidelines for calculating derived release limits for radioactive material in airborne and liquid effluents for normal operation of nuclear facilities*, the exposure to COPC and ensuing doses to various organisms is calculated using conceptual models.

These models describe the relationships between the environment and the receptors. They provide a representation of the exposure settings considered in the assessment that influence the calculation of dose to a given organism, allowing for an assessment of the risk.

For the SRBT ERA, a comprehensive screening-level assessment of all the potential radiological, non-radiological and physical stressors presented by routine facility operations was performed, in order to determine which COPC would be reasonably carried forward into more detailed quantitative analyses.

Candidate COPCs for the screening process were identified through a review of all facility processes, and the inventory of hazardous substances used as part of those processes. Benchmarking values were defined using either regulatory 'no-effect' values, or through best available research on each specific contaminant and its effect on humans and ecological receptors.

The results of this screening concluded that the only COPC of significance to human and ecological receptors was tritium, through both the gaseous and liquid effluent pathways. Noise was also carried forward through to the risk assessment as a physical stressor.

In the case of tritium, there is substantial basis to screen this COPC out and exclude it from further analysis; however, given that tritium is the only radiological COPC of relevance to the facility, and is the focus of SRBT's Environmental Management System, it has been subjected to a more detailed quantitative analysis as a matter of precaution, and to establish procedures and a comparative baseline for future iterations of the ERA process.

The quantity and distribution of tritium in the environment has been well characterized within the area surrounding SRBT throughout the history of facility operations. Using this data, coupled with the conceptual models, and the guidance and recommendations in the above-mentioned standards, allows for a comprehensive assessment of the receptor exposure levels and dose rates potentially presented by this contaminant.

In the HHRA, the highly conservative dose estimation for the most-exposed human receptor was calculated as 25.34 μSv in any year, a value that is far lower than the annual prescribed limit for persons that are not nuclear energy workers, as per the *Radiation Protection Regulations* (1 mSv, or 1,000 μSv per year).

In the EcoRA, a highly conservative estimate of the total absorbed dose rate to the most-exposed organism in the environment is 2.73 μGy per hour, a value that is far lower than both the selected population benchmark value of 100 μGy per hour, and the individual organism benchmark value of 1 mGy per day (or, 41.7 μGy per hour).

In regard to noise as the only other stressor of possible concern, analysis has indicated that the levels of exposure to noise associated with SRBT operations is within acceptable levels, and that the risk to human and ecological receptors is acceptably low.

Although there are numerous uncertainties in the assessment due to the complex nature of living systems, and the limitations of the monitoring program data applied, the considerable conservatism applied in the quantification of media concentrations and the characteristics of the critical groups of human and ecological receptors mitigates the potential for those uncertainties to lead to an under-estimation of any risk.

The conclusions of the ERA remain that the level of risk presented by routine operations, to the persons and organisms that inhabit the area surrounding the SRBT facility, are acceptably low, and that no discernable effects are anticipated at either the individual or population levels. A set of recommendations are made for future consideration, intended to help refine this assessment over time; however, as the risks are so low, no risk management recommendations are put forward at this time.

In summary, the SRBT nuclear processing facility is operating in a manner that is fully protective of human and ecological receptors residing in the area near the facility.

Table of Contents

SECTION	TITLE	PAGE
1	Introduction	14
1.1	Background	14
1.2	History of Previous Environmental Assessments	15
1.3	Framework of the SRBT ERA	19
1.4	Objectives	21
1.5	Scope	22
1.6	Organization of the ERA Report	23
2	Site Description	24
2.1	Facility Description	24
2.2	Site Location – Area Under Control of SRBT	26
2.3	Site Location – Surrounding Area	27
2.4	Meteorology	30
2.4.1	Wind	31
2.4.2	Temperature	34
2.4.3	Precipitation	35
2.5	Geology	36
2.6	Hydrogeology	37
2.7	Terrestrial Environment	38
2.8	Land Use	41
2.9	Surface Waters	42
2.10	Aquatic Environment	43
2.11	Population	46
2.12	Environmental Monitoring Program	47
2.13	Effluent Monitoring Program	48
2.14	Groundwater Monitoring Program	49
2.15	Facility Interactions	50

SECTION	TITLE	PAGE
3	Human Health Risk Assessment	52
3.1	Problem Formulation	52
3.1.1	Receptor Selection and Characterization	52
3.1.2	Selection of Stressors	56
3.1.3	Selection of Exposure Pathways	60
3.1.4	Human Health Conceptual Models	61
3.1.5	Problem Formulation - Uncertainties	62
3.2	Exposure Assessment	64
3.2.1	Description of Exposure Locations, Duration and Frequency	64
3.2.2	Exposure and Dose Calculations – Radiological	65
3.2.3	Exposure and Dose Calculations – Non-radiological	70
3.2.4	Exposure Calculations – Physical	71
3.2.5	Uncertainties in Exposure Assessment	73
3.3	Risk Characterization	75
3.3.1	Radiological Risk Characterization	75
3.3.2	Non-radiological Risk Characterization	76
3.3.3	Physical Risk Characterization	77
3.3.4	Cumulative Risk Characterization	78
3.3.5	Uncertainties in Human Health Risk Assessment	79
4	Ecological Risk Assessment	80
4.1	Problem Formulation	80
4.1.1	Valued Ecosystem Component Selection	80
4.1.2	Assessment and Measurement Endpoints	83
4.1.3	Selection of Stressors	84
4.1.4	Selection of Exposure Pathways	87
4.1.5	Ecological Conceptual Models	88
4.1.6	Uncertainty in Problem Formulation	91
4.2	Exposure Assessment	92
4.2.1	Exposure Points	92
4.2.2	Conservative Treatment of Exposure Data	93
4.2.3	Exposure and Dose Calculations	94

SECTION	TITLE	PAGE
4.2.3.1	Dose Coefficients	94
4.2.3.2	Tissue Concentrations	96
4.2.3.3	Body Weights	97
4.2.3.4	Intake Fractions	98
4.2.3.5	Bioaccumulation Factors	99
4.2.3.6	Transfer Factors	101
4.2.4	Uncertainties in Exposure Assessment	104
4.3	Effects Assessment and Risk Characterization	106
4.3.1	Radiological Risk Characterization	106
4.3.2	Non-radiological Risk Characterization	109
4.3.3	Physical Risk Characterization	110
4.3.4	Cumulative Risk Characterization	111
4.3.5	Uncertainty in Risk Characterization	112
5	Conclusions and Recommendations	113
5.1	Conclusions	113
5.2	Recommendations	115
6	Quality Assurance	116
6.1	Quality of Assessment Data	116
6.2	Quality Assurance of ERA Report	117
7	References	118
8	Appendices	121
A	Screening Tables: Stressors and Contaminants of Potential Concern	122
B	Effective Dose Calculations for HHRA - Radiological	128
C	Profile of Selected Valued Ecosystem Components (VEC)	140
D	Exposure Values Table for EcoRA	151
E	VEC Pathway Dose Calculations	154

List of Figures

FIGURE	TITLE	PAGE
1	SRBT ERA Framework	20
2	Area Under the Control of SRBT	26
3	SRBT Facility Location – Pembroke, ON	28
4	Aerial Photograph Looking Southwest of SRBT Facility	28
5	Aerial Photograph Looking Northwest of SRBT Facility	29
6	Aerial Photograph Looking Northeast of SRBT Facility	29
7	Wind Direction Distribution Windrose (2016-2025)	33
8	Land Surrounding SRBT	40
9	Nearest Point Between SRBT and Muskrat River	45
10	Location of PWTP (Green) and PPCC (Blue) on Ottawa River	45
11	Location of AOPFN Relative to SRBT	54
12	Benchmark Value Determination Process	58
13	Human Exposure Pathways (HTO/T ₂ , Gaseous Sources)	61
14	Human Exposure Pathways (HTO/T ₂ , Liquid Sources)	61
15	Noise Measurement Locations	71
16	Terrestrial Conceptual Ecological Model	90
17	Aquatic/Riparian Conceptual Ecological Model	90

List of Tables

TABLE	TITLE	PAGE
1	Wind Direction Frequency Distribution	31
2	Wind Direction Distribution (2016-2025)	32
3	Average Monthly Wind Speed (2016-2025)	33
4	Average Monthly Temperature (2016-2025)	34
5	Average Monthly Precipitation (2016-2025)	35
6	Public Dose (2010-2025)	59
7	Exposure Factors – HHRA	65
8	Effective Dose Coefficients	66
9	Input Parameters – HHRA	67
10	AOPFN Sample Results	69
11	Noise Measurement Data	72
12	VEC Selection	81
13	EcoRA Conceptual Model Pathways	88
14	Bioaccumulation Factors	100
15	Tritium Transfer Factors	103
16	Conservatively Calculated Dose Rates For Each VEC	107
17	Realistically Calculated Dose Rates For Each VEC	108

Acronyms and Abbreviations

ABS	Acrylonitrile Butadiene Styrene
AECB	Atomic Energy Control Board
ALARA	As Low As Reasonably Achievable
AOPFN	Algonquins of Pikwakanagan First Nation
BAF	Bioaccumulation Factor
Bq	Becquerel
CCME	Canadian Council of Ministers of the Environment
CMD	Commission Member Document
CNSC	Canadian Nuclear Safety Commission
COPC	Contaminant(s) of Potential Concern
CSA	Canadian Standards Association
DC	Dose Coefficient
DEL	Derived Emission Limit
DQRA	Detailed Quantitative Risk Assessment
DRL	Derived Release Limit
DU	Depleted Uranium
EcoRA	Ecological Risk Assessment
EffMP	Effluent Monitoring Program
EMP	Environmental Monitoring Program
EMS	Environmental Management System
ERA	Environmental Risk Assessment
GMP	Groundwater Monitoring Program
GTLS	Gaseous Tritium Light Source
Gy	Gray
HHRA	Human Health Risk Assessment
HT	Elemental Tritium
HTO	Tritium Oxide
ICRP	International Commission on Radiation Protection
ISO	International Organization for Standardization
MOE	Ministry of the Environment

Acronyms and Abbreviations (continued)

NSCA	Nuclear Safety and Control Act
NSPFL	Nuclear Substance Processing Facility Licence
NSPFOL	Nuclear Substance Processing Facility Operating Licence
OBT	Organically Bound Tritium
OPG	Ontario Power Generation
PAS	Passive Air Sampler
PPCC	Pembroke Pollution Control Centre
PQRA	Preliminary Quantitative Risk Assessment
PWTP	Pembroke Water Treatment Plant
RBE	Relative Biological Effectiveness
SLRA	Screening Level Risk Assessment
SRBT	SRB Technologies (Canada) Inc.
STP	Standard Temperature and Pressure
Sv	Sievert
T2	Molecular Tritium Gas
TF	Transfer Factor
UNSCEAR	United Nations Scientific Committee on the Effects of Atomic Radiation
VEC	Valued Ecosystem Component

1. Introduction

1.1 Background

SRB Technologies (Canada) Inc. (SRBT) is licensed to operate a Class I nuclear substance processing facility in Pembroke, Ontario, for the purpose of the manufacture and processing of self-luminous tritium light sources and devices.

The Canadian Nuclear Safety Commission (CNSC) is the independent regulatory body that oversees the nuclear industry, with a mandate that includes the prevention of unreasonable risk to the environment.

SRBT operates under nuclear substance processing facility licence NSPFL-13.00/2034, issued by the CNSC in 2022.

The SRBT nuclear substance processing facility operating licence and the associated Licence Conditions Handbook describes the set of requirements that are aimed at ensuring adequate protection of the environment during all phases of facility operation.

The licensing basis requires that SRBT complete and document an Environmental Risk Assessment (ERA) in compliance with Canadian Standards Association (CSA) standard N288.6-12 (R2017), *Environmental risk assessments for class I nuclear facilities and uranium mines and mills*.

1.2 History of Previous Environmental Assessments

This ERA is based on the cumulative knowledge gained over thirty years of facility operations and monitoring activities, as described here.

The SRBT facility in Pembroke, Ontario was established in 1990, initially operating under a radioisotope processing licence issued by the Atomic Energy Control Board (AECB). This licence permitted SRBT to process tritium gas for the manufacture of gaseous tritium light sources, and devices that used these light sources.

Covering the first few years of operation, a set of Derived Release Limits (DRL) calculations were tabulated by Atomic Energy of Canada Limited on behalf of SRBT in 1990 [1], and were accepted by the AECB at that time, in support of licensing the facility for radioisotope processing.

At the time of initial licensing, consideration of the impact of facility operations was rendered by AECB staff pursuant to the *Environmental Assessment and Review Process Guidelines Order* (SOR/84-467).

This process was also similarly applied for processing licence amendments issued in 1991 and again for 1995, when an environmental screening decision report was issued by AECB staff in November 1994 [2]. The facility operated within limits stemming from the conclusions of that report for several years, and no major environmental issues were identified at that time as a result of this review.

In 1996, SRBT contracted Canatom Inc. to review and revise the DRL calculations that were originally tabulated in support of initial facility operations in 1990. A report detailing the revised limits was finalized in 1997 and submitted to AECB staff after several exchanges of review and comment [3].

The *Nuclear Safety and Control Act* (NSCA) replaced the former *Atomic Energy Control Act* in 2000, and with this Act, the Canadian Nuclear Safety Commission (CNSC) was established with an expanded mandate that included the protection of the environment.

As part of this fundamental regulatory shift, the SRBT facility was reclassified under the new regulations as a Class IB nuclear substance processing facility. With this change, a host of expanded regulatory requirements were now applicable to the operation of the facility, including more complex quality assurance, radiation protection and environmental protection measures.

During initial licensing as a Class IB nuclear substance processing facility pursuant to the new NSCA, CNSC staff completed a screening assessment pursuant to the *Canadian Environmental Assessment Act*.

This assessment was submitted to the Commission as CMD 00-H28.B on December 13, 2000, and was performed in close consultation with Environment Canada, Health Canada and the Ontario Ministry of the Environment. [4]

The screening assessment concluded that SRBT's facility operations were not likely to cause adverse environmental effects, providing additional mitigation measures were implemented primarily with respect to facility fire protection [5].

The facility was operated for five years under nuclear substance processing facility operating licence NSPFOL-13.00/2005, and SRBT applied for licence renewal prior to its expiry in 2005.

As part of the renewal process, SRBT commissioned a comprehensive review of the Canatom DRL calculations in both 2004 [6] and again in 2006 [7].

SRBT also implemented an expanded Environmental Monitoring Program (EMP) in 2005-06, expanding the amount of data gathered in the environment surrounding the facility.

In November 2005, CNSC staff issued an order to SRBT to complete a groundwater contamination study [8]. The order required SRBT to define the extent and magnitude of tritium contamination in the groundwater on and around the facility, and to assess the potential adverse impacts on the environment, persons and land use.

The CNSC issued SRBT an operating licence for a period of one year after two days of hearings in September and November 2005 [9].

This licence contained several restrictions obligating SRBT to undertake an Action Plan to correct identified program deficiencies. In addition, the order issued in November 2005 was revoked, and instead, a licence condition was added to the new operating licence.

Under NSPFOL-13.00/2006 and its subsequent amendment NSPFOL-13.01/2006, SRBT began the process of implementing the required improvements to several of its key safety programs, including those focused on the protection of the environment.

The groundwater study was completed, and an initial report submitted to CNSC staff on March 2006 [10]. An expanded study was completed over the next few years with an increased monitoring well array, culminating in a final report being submitted in January 2008 [11].

SRBT also completed a suite of assessments focused on qualifying and quantifying the environmental impact of the operation of the facility.

These assessments included:

- *Systematic and Quantitative Analysis of Tritium Sources and Their Potential Contribution to Groundwater Contamination (2007)*
- *Comprehensive Report – Groundwater Studies at the SRB Technologies Facility, Pembroke, ON (2008)*
- *Release Limit Rationale in Support of Licence Renewal Application (2009)*

While improving the understanding of the impact of facility operation on groundwater resources and the environment during this time, SRBT continued to function under nuclear substance processing facility licences issued in 2007 [12], 2008 [13] and 2010 [14]. SRBT's Environmental Management System (EMS) was also continuously improved as these impacts were further studied.

The CNSC issued a nuclear substance processing facility operating licence for a five-year period in 2010. SRBT continued to collect and analyze a significant amount of data on facility environmental impacts as part of a comprehensive EMS and monitoring program set.

As part of the process of renewing the SRBT operating licence in 2015, CNSC staff documented and presented an Environmental Assessment Information Report as part of the submitted Commission Member Document [15].

The information presented in this report detailed the set of identified environmental aspects of operation of the facility, and the monitoring programs that ensured protection of the environment. The report concluded by supporting CNSC staff's recommendation of renewal of the SRBT operating licence for a period of ten years. On June 29, 2015, SRBT was issued a seven-year operating licence by the CNSC [16].

As part of the renewed licensing basis, SRBT began the process of revamping their EMS to comply with the latest versions of several CSA standards. A gap analysis was completed and submitted to CNSC staff in 2015-16, along with a comprehensive action plan intended to ensure full compliance with these standards [17].

Over the following several years, SRBT continuously improved several environmental programs, including the EMP, the Effluent Monitoring Program (EffMP), and the Groundwater Monitoring Program (GMP). CNSC staff reviewed and accepted these new and revised program documents as the action plan was executed in a controlled fashion over time.

The cumulative result of these actions was a comprehensive and robust EMS that complies with all applicable CSA N288-series standards, thus ensuring continued protection of the environment throughout facility operations.

The initial version of the ERA was completed in December 2020, as the final action of the aforementioned N288-series action plan. The assessment was submitted to CNSC staff on December 23, 2020 [18], and published to the SRBT website in full.

CNSC staff provided feedback on Revision A [19] after completing the regulatory review and assessment process. This feedback was then incorporated into the ERA by SRBT, with Revision B being finalized in April 2021. CNSC staff concluded that Revision B was acceptable on April 22, 2021 [20], and the assessment was posted to the SRBT website in full.

The N288.6 standard requires that a facility ERA be reviewed and, if necessary, revised on at least a five-year cycle. This report incorporates the findings of this review, as well as updated data obtained through routine and non-routine environmental sampling activities.

1.3 Framework of the SRBT ERA

Canadian Standards Association (CSA) standard N288.6-12, *Environmental risk assessments at Class I nuclear facilities and uranium mines and mills* defines how an environmental risk assessment should be designed and implemented.

This standard is incorporated in the SRBT Licence Conditions Handbook, and thus represents a key licensing basis standard as part of our overall Environmental Management System (EMS).

A tiered assessment process is recommended by the standard, with the level and depth of assessment being tied to the complexity and risk-profile of the particular nuclear facility. The three defined tiers are as follows:

➤ Tier 1: Screening Level Risk Assessment (SLRA)

This assessment level broadly identifies where there may be either receptors or stressors that are of interest, and may require quantitative treatments at a higher level. Highly conservative estimates of stressor exposure are contrasted with highly conservative and broadly applicable benchmarks to determine if there is any potential for instances where exposure might exceed the benchmark. Should none be identified through the screening process, then no further assessment is required.

➤ Tier 2: Preliminary Quantitative Risk Assessment (PQRA)

The identified stressors and receptors are quantitatively assessed using readily available site data. Levels of stressor exposure are more realistically quantified for site-specific conditions and receptors. A determination is made on if there are any outstanding concerns that need further investigation and assessment.

➤ Tier 3: Detailed Quantitative Risk Assessment (DQRA)

Where there are continuing concerns that were not fully resolved by the PQRA, a DQRA may be required. This could include a refinement to the risk characterization in order to eliminate uncertainty, or more focused and specific research activities to better understand and quantify the risks to receptors, or environmental effects monitoring.

A graphical representation of the framework used by SRBT for the completion of ERA is presented in Figure 1.

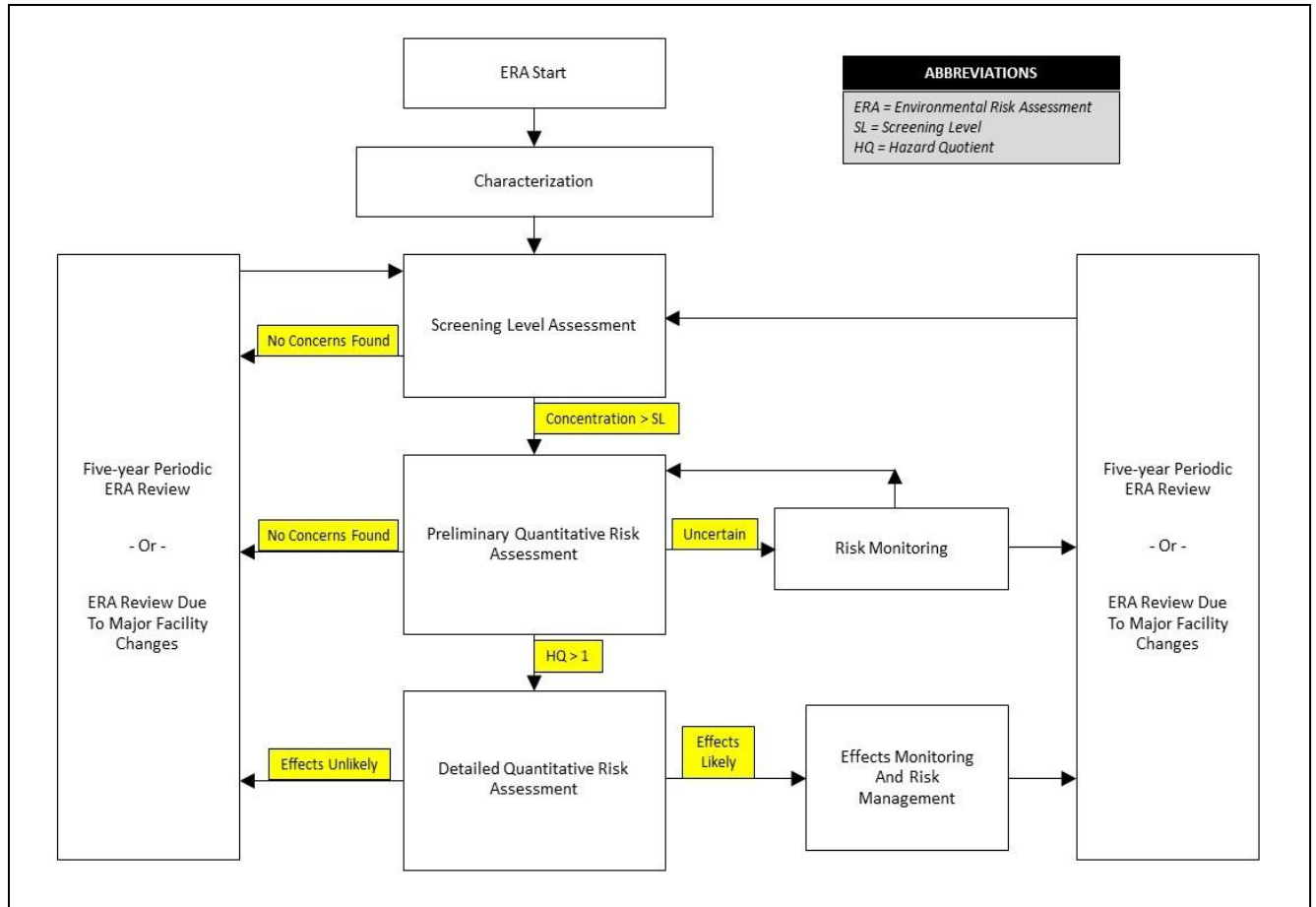

FIGURE 1: SRBT ERA FRAMEWORK

1.4 Objectives

The main objectives of the SRBT ERA are:

- To identify and assess the potential risks to both human and non-human receptors, as a result of current operations of the nuclear substance processing facility,
- To assess whether the scope and focus of the programs that comprise SRBT's EMS are reasonable and appropriate, and
- To determine if there is any need for further assessment or actions in order to optimize the management of environmental risk associated with facility operations.

As well, the completion of an ERA and the documentation of the report are intended to ensure that the requirements of the SRBT licensing basis is met, specifically in the context of compliance with CSA Standard N288.6-12, *Environmental risk assessments for Class I nuclear facilities and uranium mines and mills*.

1.5 Scope

The scope of the SRBT ERA includes:

- The completion of a human health risk assessment (HHRA),
- The completion of an ecological risk assessment (EcoRA),
- The recommendations of any actions that may be taken to achieve the objectives of the ERA.

Based upon data generated through the SRBT EMP and GMP over several years, the accepted spatial scope of the ERA is defined as the area surrounding the facility, extending out to a radius of 3,500 metres from the active ventilation exhaust stacks.

This radius corresponds to the distance to the furthest routinely sampled area in the EMP that is not classified as representative of background. Beyond this distance, EMP measurements demonstrate that tritium activity is at, or very close to, background levels. Refer to section 2.3 of this report for additional details.

Secondary assessment areas shall be researched and included if there are benefits or unique information that can contribute to the depth and value of the facility ERA, including areas where the nearest known usage of land or waterways by Indigenous communities takes place.

Any action plans generated as an output or recommendation of the ERA will be managed in accordance with the relevant SRBT Management System processes.

1.6 Organization of the ERA Report

The assessment has been carried out in accordance with the requirements of CSA N288.6-12. The report has been organized in a fashion that is commensurate with the recommendations of this standard, in order to provide ease of review and present data in a logical fashion.

The sections of the report are itemized as follows:

- Section 1: Introduction
- Section 2: Site Description
- Section 3: Human Health Risk Assessment
- Section 4: Ecological Risk Assessment
- Section 5: Conclusions and Recommendations
- Section 6: Quality Assurance
- Section 7: References
- Section 8: Appendices

2. Site Description

2.1 Facility Description

The SRBT nuclear substance processing facility uses vacuum-based processing equipment in order to process tritium gas (T_2) for the purposes of manufacturing gaseous tritium light sources (GTLS).

A GTLS consists of a hermetically sealed borosilicate glass capsule, internally coated with a phosphorescent powder and filled with tritium gas. The low-energy beta radiation emitted by the tritium gas upon decay interacts with the powder and causes it to emit visible light. These 'Betalights'® are then installed into various devices which provide a reliable, uninterrupted source of light when conventional power sources are unfeasible or suboptimal.

SRBT operates several 'processing rigs' in order to create these GTLS. These rigs are vacuum-based systems of valves, pumps and tubing, and are designed to have a tritium 'trap' attached in order to fill light sources. This trap contains a metallic adsorbent that will contain pure tritium gas in a solid form (i.e. a 'tritide') at room temperature, and will release pure tritium gas when heated to around 400 degrees Celsius.

When these processes are performed at vacuum pressures in the absence of air or other gaseous contaminants, tritium gas can effectively be used to fill light sources. This is the principal technical characteristic of the processing facility with respect to tritium.

Tritium processing equipment is located in Zone 3 of the facility, denoting the radiological zone with the greatest potential for exposure to hazards posed by the use of tritium gas. Processing takes place in an area known as the Rig Room. Within this area, four double-sided ventilated cabinets house the main filling stations where light sources are filled with tritium.

A second area within Zone 3 is known as the Laser Room. In this area, laser cutting equipment is used to process long, thin GTLS known as laser sticks. These sticks are cut to specification using specialized lasers.

Finally, within Zone 3 is the Tritium Laboratory, which houses equipment known as the Bulk Splitter. This system is used to take bulk amounts of tritium purchased by SRBT on specialized containers and subdivide it onto the tritium traps that will interface with the processing rigs. The principles of operation of the bulk splitter are the same as those used on the processing rigs.

The reader may refer to Section 6 of the SRBT Safety Analysis Report for additional technical details on the nuclear substance processing facility aspects of SRBT operations [21].

In order to manufacture gaseous tritium light sources for tritium filling, several processes are implemented where borosilicate glass is shaped and internally coated with a zinc sulfide-based powder. It is this powder that luminesces when exposed to the low-level beta radiation emitted by the pure tritium gas inside the light once completed.

The manufacture of light source 'pre-forms' involves limited chemical processes in the Coating Room, performed under negative ventilation. These processes are conducted pursuant to Certificate of Approval – Air number 5310-4NJQE2, issued by the Ontario Ministry of the Environment and Climate Change [22].

Although SRBT is a manufacturing facility, there are few physical aspects of operations beyond released substances to effluent that interact with the surrounding environment. There is no vehicular traffic of note, nor are there significant thermal influences, night lighting, or any direct discharges to bodies of water that arise as a result of facility operations.

2.2 Site Location – Area Under Control of SRBT

The SRBT facility is located at 320 Boundary Road in Pembroke, Ontario. The building which houses the facility is situated on parts of lots 28 and 29 of Concession 1, and was constructed in 1990 with a slab-on-grade floor.

The current zoning of the facility is M3 (Industrial Park Zone) as designated under municipal by-law 88-17. This zoning excludes residential use.

SRBT fully controls approximately 1,400 square metres of the interior floor space of the building, as well as the immediate surrounding grounds outside of the facility.

A fenced compound is maintained on the northwest corner of the facility, housing the primary active ventilation system components (fans, motors, stacks).

The area under the control of SRBT is indicated by the red demarcated boundary in Figure 2.

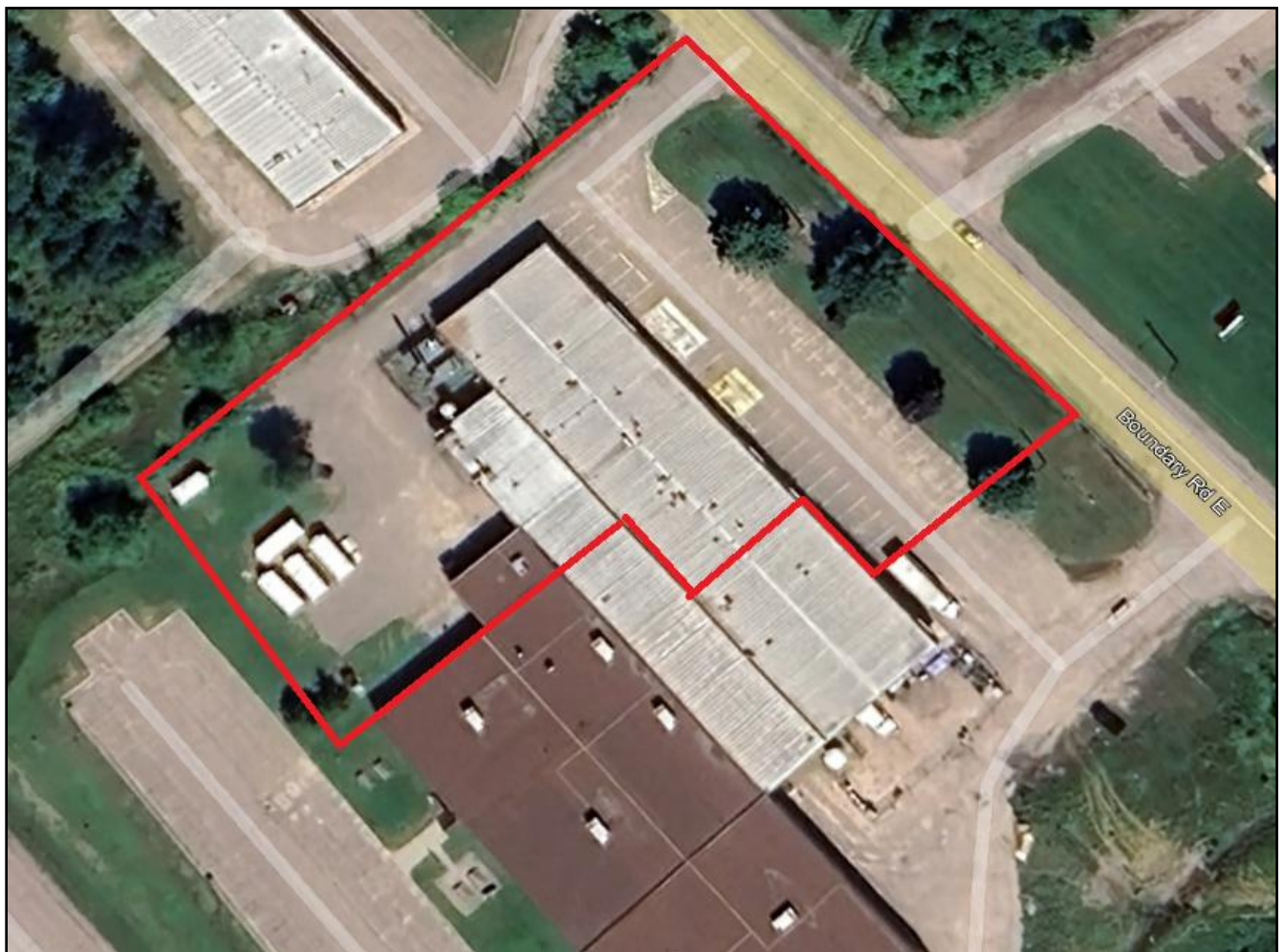

FIGURE 2: AREA UNDER THE CONTROL OF SRBT

2.3 Site Location – Surrounding Area

The SRBT facility resides within an area known as TransCanada Corporate Park – an industrial park within the boundary of the City of Pembroke.

Within the same building as the SRBT facility are two other commercial / industrial businesses. The adjacent business is a company that specializes in the manufacture of personal protective equipment and clothing intended for such application as bomb disposal and military special operations. A third tenant provides various industrial process gas and equipment to local customers.

Directly across the road from SRBT is a commercial pool and spa services vendor, as well as a small local propane distribution facility. Next door to the building housing the SRBT facility is another similar, but currently unoccupied, commercial building.

Farmland is generally to the west of the facility, extending out approximately 300-500 metres. To the southwest there are two major-chain hotels, and a local distillery. Further to the west is the Pembroke Fire Department and the local detachment of the Ontario Provincial Police.

To the northeast of the property is the Pembroke and Area Community Centre, which houses a full size skating rink. A few other businesses, and further out, residences are located within 500 metres to the north and north east. To the south of the facility, a commercial building is located about 250 m away. To the south east, a lumber yard is present.

The nearest zoned residential area is called Johnson's Meadows, which was originally developed in the 1970s, and has expanded since. From the location of the active ventilation system stacks, the nearest residence is approximately 250 metres to the northwest. In addition, a narrow band of land along Boundary Road to the southeast includes residential properties.

The main portion of the City of Pembroke lies north of the facility.

Based upon data generated through the SRBT EMP and GMP over several years, the area of meaningful influence of the SRBT facility extends out to a radius of no more than 3,500 metres from the active ventilation exhaust stacks [23].

Beyond this distance, environmental measures of SRBT's most notable COPC (tritium) are effectively below programmatic quantification (i.e. typically less than 0.70 Bq/m³ measured in air via EMP).

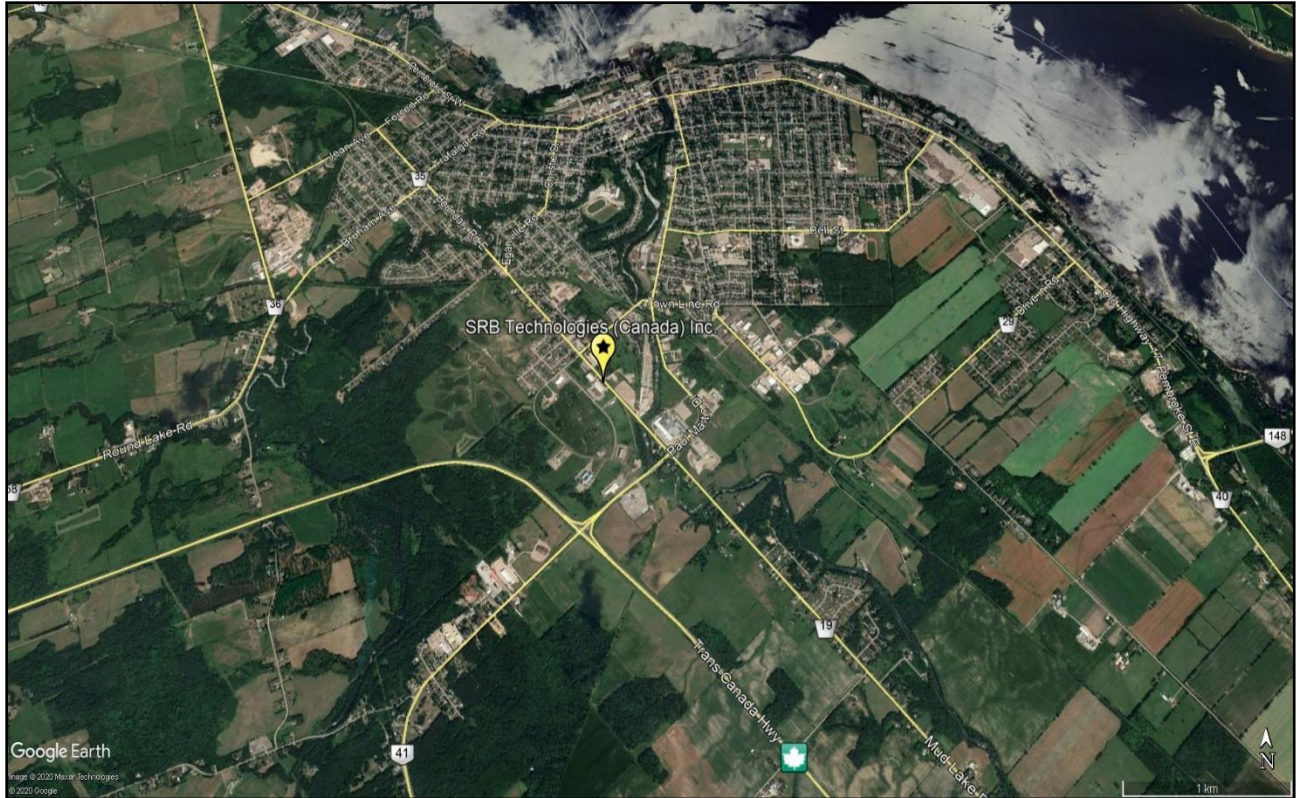

FIGURE 3: SRBT FACILITY LOCATION – PEMBROKE, ON



FIGURE 4: AERIAL PHOTOGRAPH LOOKING SOUTHWEST OF SRBT FACILITY



FIGURE 5: AERIAL PHOTOGRAPH LOOKING NORTHWEST OF SRBT FACILITY



FIGURE 6: AERIAL PHOTOGRAPH LOOKING NORTHEAST OF SRBT FACILITY

2.4 Meteorology

The climate of Pembroke is classified as warm-summer humid continental (Köppen Code: Dfb), as with much of southern and eastern Ontario.

Meteorological data are presented as a component of the complete description of the site and surrounding environment.

Tables of meteorological data presented here include wind and temperature data compiled from the latest version of the SRBT Derived Release Limits (DRL) report [24], as well as the most recent ten years of data from the SRBT weather station (2016-2025), except for the following periods:

- April – June 2016 (weather station battery failure);
- Wind data between April 2020 – September 2021 (wind sensor malfunction);
- Temperature data between March – September 2021 (major weather station component refurbishment and replacement); and
- June – December 2025 (datalogger obsolescence / replacement, plus sensor failure).

2.4.1 Wind

The prevailing wind direction at the facility is generally dominated by west → east patterns.

The data presented in Table 1 is taken from the 2021 SRBT DRL document [24] (page 11).

WIND DIRECTION		PETAWAWA WEATHER STATION (1989-2004)	SRBT WEATHER STATION (2011 – 2015)		SRBT WEATHER STATION (2017 – 2019)	
FROM	TO		24 hr	12 hr	24 hr	12 hr
N	S	4.16%	5.90%	6.03%	5.31%	5.23%
NNE	SSW	2.45%	6.10%	6.55%	7.04%	7.19%
NE	SW	2.53%	5.20%	5.34%	5.88%	6.12%
ENE	WSW	2.38%	4.43%	5.01%	3.12%	3.47%
E	W	3.79%	5.56%	5.75%	3.29%	3.41%
ESE	WNW	10.58%	5.32%	5.02%	4.00%	4.18%
SE	WN	12.17%	5.72%	6.10%	2.72%	2.89%
SSE	NNW	4.64%	5.86%	6.11%	3.73%	3.68%
S	N	3.49%	5.26%	5.08%	3.91%	3.99%
SSW	NNE	3.69%	5.66%	5.18%	5.00%	4.89%
SW	NE	4.86%	6.49%	6.01%	4.91%	4.58%
WSW	ENE	6.26%	8.16%	7.34%	7.20%	5.84%
W	E	9.41%	7.74%	7.24%	13.40%	12.22%
WNW	ESE	10.68%	9.19%	9.75%	14.87%	15.94%
NW	SE	11.35%	7.80%	8.05%	10.43%	11.31%
NNW	SSE	7.55%	5.59%	5.44%	5.19%	5.06%

TABLE 1: WIND DIRECTION FREQUENCY DISTRIBUTION

Wind directional data from 2016-2025 was obtained via the recorded data from the on-site weather station, and is summarized in Table 2.

The direction and average speed of wind is captured every five minutes by the station. A total of 898,520 points of data were recorded in the ten-year period.

WIND DIRECTION DISTRIBUTION – SRBT WEATHER STATION			
FROM	TO	COUNTS	% OF TIME
N	S	88,457	9.8
NNE	SSW	54,500	6.1
NE	SW	40,640	4.5
ENE	WSW	33,332	3.7
E	W	34,861	3.9
ESE	WNW	44,240	4.9
SE	WN	68,123	7.6
SSE	NNW	50,468	5.6
S	N	39,199	4.4
SSW	NNE	33,148	3.7
SW	NE	36,855	4.1
WSW	ENE	41,125	4.6
W	E	72,471	8.1
WNW	ESE	91,996	10.2
NW	SE	108,394	12.1
NNW	SSE	60,711	6.8

TABLE 2: WIND DIRECTION DISTRIBUTION (2016-2025)

Relative wind direction frequencies are plotted as a wind rose graph in Figure 7, while monthly average wind speeds from the SRBT weather station in 2016-2025 are presented below in Table 3.

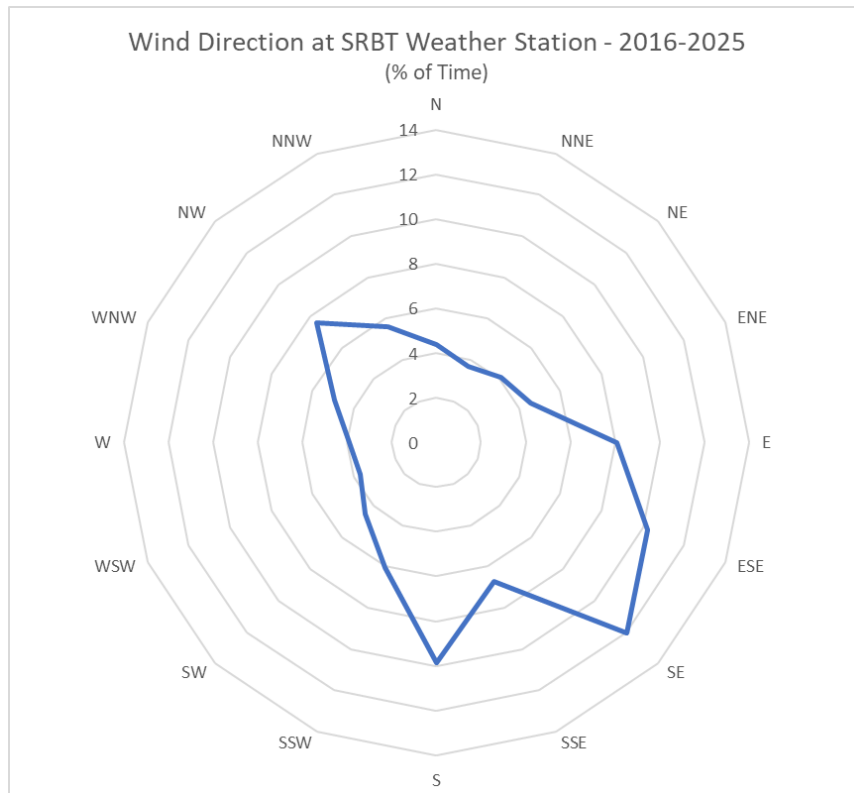

FIGURE 7: WIND DIRECTION DISTRIBUTION WINDROSE (2016-2025)

AVERAGE MONTHLY WIND SPEED – SRBT WEATHER STATION	
MONTH	WIND SPEED (m/s)
January	2.9
February	3.0
March	3.5
April	3.4
May	3.0
June	2.6
July	2.2
August	2.3
September	2.1
October	2.7
November	2.9
December	3.0
AVERAGE	2.8

TABLE 3: AVERAGE MONTHLY WIND SPEED (2016-2025)

2.4.2 Temperature

For the purposes of the ERA, average monthly temperature data from 2016-2025 were obtained via the recorded data from the on-site weather station, and are presented in Table 4.

AVERAGE MONTHLY TEMPERATURE – SRBT WEATHER STATION	
MONTH	TEMPERATURE (°C)
January	-8.9
February	-7.8
March	-1.5
April	5.9
May	13.9
June	17.7
July	21.4
August	19.3
September	15.3
October	8.4
November	2.7
December	-5.6
AVERAGE	6.7

TABLE 4: AVERAGE MONTHLY TEMPERATURE (2016-2025)

2.4.3 Precipitation

For the purposes of the ERA, average monthly precipitation data from 2016-2025 were obtained via the recorded data from the on-site weather station, and are presented in Table 5.

PRECIPITATION - SRBT WEATHER STATION	
Month	Rain Equivalent Precipitation (mm)
January	35.6
February	24.9
March	45.3
April	96.1
May	63.0
June	97.3
July	84.8
August	109.8
September	64.7
October	71.6
November	46.0
December	35.6
Year	780.4

TABLE 5: AVERAGE MONTHLY PRECIPITATION (2016-2025)

2.5 Geology

The description of the local geology presented here is based upon SRBT's Comprehensive Report on Groundwater Studies document [11].

The area surrounding the facility is located on the oldest part of the Canadian Shield, in the Central Meta-Sedimentary Belt Boundary and the Central Gneiss Belt of (tectonic) Grenville Province. The dominant crust is the "Algonquin Terrane", and the most common deposit is the Opeongo domain. The Ottawa Valley Clay Plain and the Petawawa Sand Plain are the physiographic regions present.

The City and surrounding Laurentian Valley Township encompass a wide representation of Paleozoic geology, and Precambrian rocks dominate as they are present throughout the township and at the west and southwest perimeter of the city. Other Paleozoic formations also exist.

The Rockcliffe Formation runs along the Muskrat River and into the Ottawa River. It is also found in association with the Gull River and Bobcaygeon Formations east of the Muskrat River and on Morrison Island. The Gull River and Bobcaygeon Formations are also found at the east end of Beckett Island and run eastwards north of Cotnam Island. The Oxford Formation is found only just south of Beckett Island.

Within the study area, Paleozoic rock formations are Precambrian, undifferentiated metamorphose and igneous rocks. Starting at the northeast corner of Boundary Road and Paul Martin Drive and continuing northwards, the Oxford Formation is present. A bedrock fault runs along parallel to Boundary Road in front of the SRBT facility.

Overburden typically includes a thin layer of topsoil, underlain at some locations by silty sand or gravel fill with underlying native material consisting mainly of grey silty clay, generally compact above the water table.

Bedrock is encountered between 5.2 to 7.5 metres below ground surface, and consists of shaley limestone. The upper 1 to 3 metres of bedrock exhibits fracture, with rock quality designation values between 0% and 75%.

2.6 Hydrogeology

An extensive amount of research has been invested in understanding the hydrogeology and groundwater conditions at the SRBT facility in the last fifteen years. The description of the local hydrogeology presented here is based upon the description provided in SRBT's Comprehensive Report on Groundwater Studies document.

Overburden generally consists of silty clay and bedrock consists of shaley limestone that is typically fractured near the surface. The characteristics of this overburden lead to relatively slow rates of initial infiltration and subsequent lateral groundwater movement.

Groundwater levels in the area range between 120-130 metres above sea level (masl), with seasonal variations ranging over 7 metres. The depth to bedrock at the site ranges from 5.2 to 7.5 m below surface.

Vertical hydraulic gradients have been determined to be about 1.0 through the overburden, about 0.3 through the top of the bedrock and 0.6 through the shallow bedrock. Horizontal gradients through the zone at the top of bedrock and in the bedrock have been determined to be on the order of 0.02.

Groundwater flow is predominately downward within the clay, until the underlying higher conductivity layers of bedrock surface and shallow bedrock are encountered.

The direction of groundwater flow near the facility is generally to the east toward the Muskrat River. The groundwater velocities in the horizontal direction in the shallow bedrock have been calculated to have an average value of about 4 m/a.

For a thoroughly detailed picture of the hydrogeology of the area where the facility is located, the reader is invited to consult the 2008 Comprehensive Report – Groundwater Studies [11].

2.7 Terrestrial Environment

SRBT is located on the southern outskirts of the City of Pembroke, which lies within Ecoregion 6E under provincial classification.

Climax vegetation in this ecoregion is characterized by mixed hardwoods. There are some areas within a few kilometres of the SRBT facility where typical regional forest cover occurs; however, within 1,000 metres of the facility, there is a very limited presence of meaningful areas of forest, wetland or other natural cover.

The narrow riparian zone of the Muskrat River is the only noteworthy natural area within 1 km of the SRBT facility. For this reason, this habitat has been included as a location for assessment in the Ecological Risk Assessment component of this ERA.

The area immediately surrounding the facility is varied in terrestrial character. In general, much of the land to the north, northwest and northeast of the facility consists of moderately dense urban and suburban development, while the rest of the surrounding areas to the south, east and west are much more open, with dispersed housing, open grassy fields, some limited forested areas, a small river, and various swamps, drainage ditches, seasonal creeks and streams.

As the facility is located very near the boundary of the City of Pembroke, and exists within a relatively urbanized and developed zone, the populations of flora and fauna are typical of modified landscapes. Species typical of more natural landscapes are not widely encountered in the area immediately surrounding the facility.

Types of known or suspected animals inhabiting or frequenting the scoped terrestrial assessment area include (but are not limited to):

Birds:

- American Crow (*Corvus brachyrhynchos*)
- Barn Swallow (*Hirundo rustica*)
- Bank Swallow (*Riparia riparia*)
- Bobolink (*Dolichonyx oryzivorus*)
- Canada Goose (*Branta canadensis*)
- Chimney Swift (*Chaetura pelagica*)
- Eastern Meadowlark (*Sturnella magna*)
- Ring-billed Gull (*Larus delawarensis*)
- Snow Bunting (*Plectrophenax nivalis*)

Mammals:

- Chipmunk (*Tamias striatus*)
- Common Raccoon (*Procyon lotor*)
- Groundhog (*Marmota monax*)
- Muskrat (*Ondatra zibethicus*)
- Red Squirrel (*Tamiasciurus hudsonicus*)
- White-tailed Deer (*Odocoileus virginianus*)

Invertebrates:

- Earthworms (*Lumbricus terrestris*)
- Various species of Dragonfly (*Genus: Anisoptera*)
- Monarch Butterfly (*Danaus plexippus*)
- Various species of slugs and snails (*Class: Gastropoda*)

Reptiles:

- Eastern Garter Snake (*Thamnophis sirtalis sirtalis*)
- Eastern Ribbon Snake (*Thamnophis saurita*)
- Blanding's Turtle (*Emydoidea blandingii*)

Notable terrestrial plants that are known to grow within the scope of assessment area include:

- Maple (*Genus: Acer*)
- White Pine (*Pinus strobus*)
- Poplar (*Genus: Populus*)
- Birch (*Genus: Betula*)
- Butternut (*Juglans cinerea*)
- Goldenrod (*Solidago canadensis*)
- Various species of mosses (*Division: Bryophyta*)

A map of the surrounding terrestrial environment is shown in Figure 8.

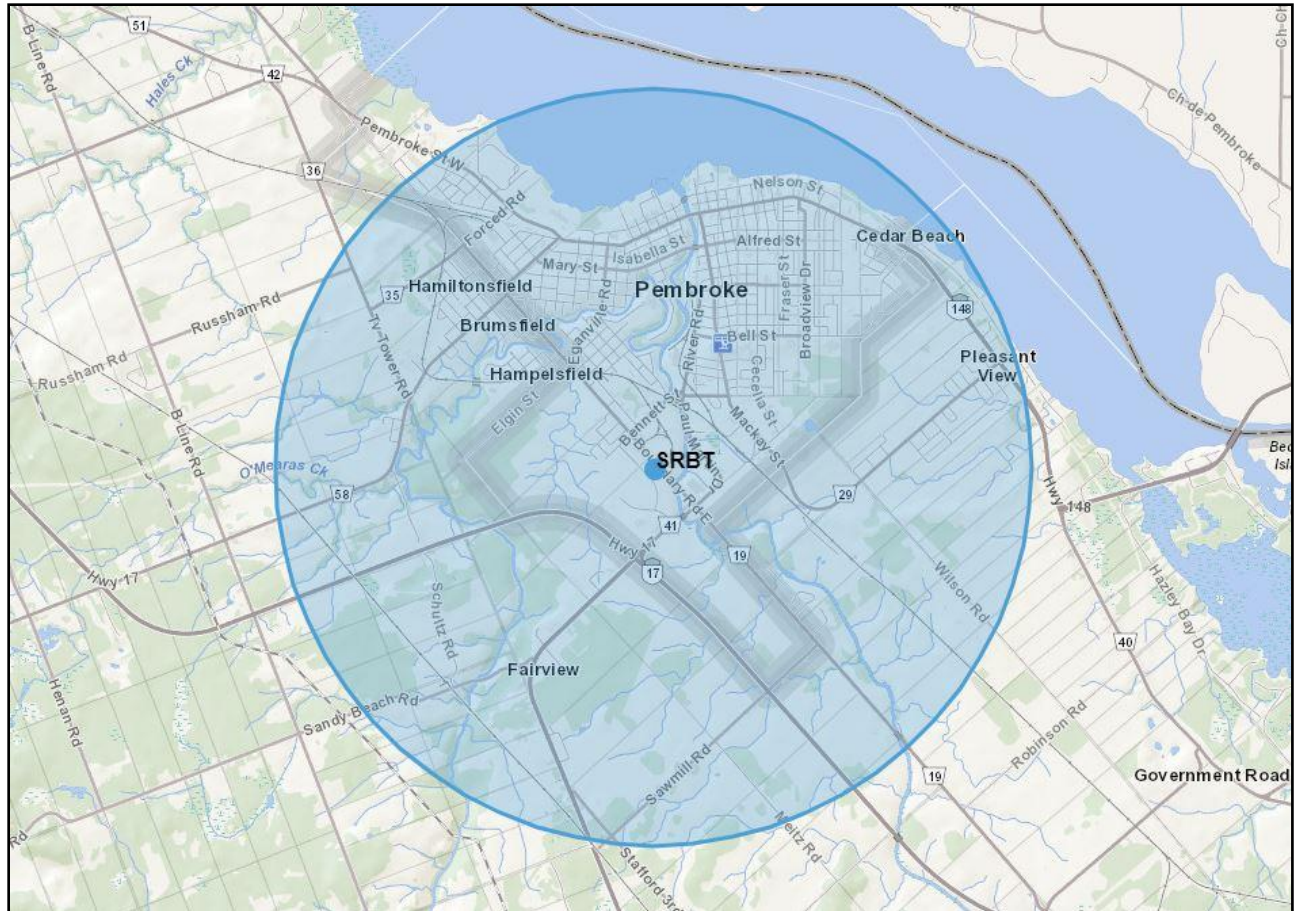

FIGURE 8: LAND SURROUNDING SRBT

The 3,500 metre radius of the scoped area of the ERA is represented in Figure 8, along with forested (green) and aquatic (blue) areas. White areas are cleared, either for agricultural use outside of the city limits, or for urban development within.

2.8 Land Use

For the purposes of a description of how the land surrounding the facility is used, it can be generalized that there is a transect running from north west down through the south east compass points relative to the facility location, represented for the most part by Pembroke's Boundary Road.

In the area generally to the north and east, land use is devoted to either urban or rural-style residential dwellings, or for commercial / business / industrial establishments.

A small residential area known as Johnson Meadows subdivision lies in the area west - northwest of the facility beginning about 250 metre away, and within approximately 600 metres of the facility.

On the western side of the transect created by Boundary Road lies an area designated as the TransCanada Corporate Park, in which the SRBT facility is located. This park is currently used for industrial, professional- and public-service purposes, with the local station of the Ontario Provincial Police and the Pembroke Fire Department all having been established in buildings within the scoped area.

As well, multiple commercial establishments are diffusely situated to the west, south and southwesterly directions, including two hotels, a truck stop / restaurant / gas station, and various other businesses along Highway 41.

A proportion of the surrounding land within the area of interest is routinely used for agricultural purposes to the west, south and east of the facility. Limited forested areas exist to the west as well, in and around the Indian River / Shady Nook areas to the west and southwest of SRBT.

2.9 Surface Waters

There are no large bodies of water that directly interface with the facility or the property upon which the facility resides.

To the south and east of the property lies the Muskrat River, which flows in a northward direction through the City of Pembroke.

The Muskrat River is approximately 400 m away from the site of licensed activity at its nearest point, due directly east of the facility. This river is quite narrow and its typical elevation is approximately 20 meters below the elevation of the SRBT facility. The river near the facility is not generally used for sport fishing.

The smaller Indian River lies to the north and west of the facility, being approximately 1,000 m away from the facility at its nearest point due directly north.

Both of these rivers meet within the city, with the combined channel meandering for another 1.5 km north, ultimately discharging to the Ottawa River by the Pembroke City Hall.

The Ottawa River lies north of SRBT, approximately 2.5 km due north at its nearest point. This river delineates the north / northeastern boundary of the city of Pembroke, and is routinely used for sport fishing and recreation during summer months, as well as ice fishing in the winter.

2.10 Aquatic Environment

The nearest aquatic and riparian areas relative to the SRBT facility is the Muskrat River, which lies approximately 400 m to the east and southeast of the facility.

The Muskrat River at Pembroke exhibits a highly variable volumetric flow rate, depending on season and watershed rain fall.

Historical measurements on record since 1969, obtained at a monitoring station in Pembroke (https://wateroffice.ec.gc.ca/report/historical_e.html?stn=02KC015) indicate a range of instantaneous volumetric flow between a minimum of 0.044 m³/sec (2012-03-21, 2000h) to a maximum of 67.0 m³/sec (2019-04-26, 2240h). Water level measurements taken since 2008 at the station also vary, from a minimum of 3.392 m (October 2012) to a maximum of 5.077 m (January 2011). Within the assessment area, the river span measures up to approximately 40 metres across.

Within the boundaries of the City of Pembroke, the banks of the meandering Muskrat River are generally occupied by limited riparian habitat; however, to the southeast of the SRBT facility within the assessment area, the river presents significantly greater amounts of natural habitat of this type, as population and dwelling density is far lower than within the city limits. Wetland habitat (marsh and swamp) can be found along the banks of the river in this direction.

To the north of the SRBT facility lies the Ottawa River, the second largest river in eastern Canada (<https://www.ottawariverkeeper.ca/watershed-fact/>).

A limited proportion of the river which flows by Pembroke lies within the scoped assessment area, defined generally as the southern portion of the river beginning at the Pembroke Water Treatment Plant (PWTP) northwest of the facility, through Riverside Park and the Pembroke Marina to the north, and finally terminating at the Pembroke Pollution Control Centre (PPCC) to the northeast.

The closest point of this river relative to SRBT lies approximately 2.5 km to the north, near Algonquin College, where there are very limited riparian habitats along the Kiwanis Way Waterfront Trail. The remaining shoreline area is greatly affected by the urban nature of the city, with numerous riverfront dwellings and some sandy beach areas.

The PPCC is the treatment and discharge point of the municipal sanitary and storm drainage systems. SRBT is licenced by the CNSC to release limited amounts of tritium to the municipal sewer system, and also has approval from the City of Pembroke to release limited radiological and non-radiological substances to sewer as well. As such, the assessment scope includes this discharge point for any potential contaminants of concern (COPC), and the human and ecological risks associated with these releases.

Examples of the types of aquatic species known or suspected to exist within the assessment area include (but are not limited to):

Amphibians and Reptiles:

- Blanding's Turtle (*Emydoidea blandingii*)
- Green Frog (*Lithobates clamitans*)
- Midland Painted Turtle (*Chrysemys picta marginata*)
- Northern Leopard Frog (*Lithobates pipiens*)
- Snapping Turtle (*Chelydra serpentine*)

Fish:

- American Eel (*Anguilla rostrate*)
- Brook Trout (*Salvelinus fontinalis*)
- Channel Catfish (*Ictalurus punctatus*)
- Lake Sturgeon (*Acipenser fulvescens*)
- Rainbow Trout (*Oncorhynchus mykiss*)
- Smallmouth Bass (*Micropterus dolomieu*)
- Longear Sunfish (*Lepomis magalotis*)
- Walleye (*Stizostedion vitreum*)

Aquatic Plants:

- Bulrushes (*Typha latifolia*)
- Hornwort (*Division: Anthocerotophyta*)
- Horsetail (*Genus: Equisetum*)
- Tape grasses (*Genus: Vallisneria*)
- Various ferns

Figure 9 shows the nearest physical points between the facility and the Muskrat River (blue circles).



FIGURE 9: NEAREST POINT BETWEEN SRBT AND MUSKRAT RIVER

Figure 10 shows the location of the PWTP (green circle) and the PPCC (blue circle) on the banks of the Ottawa River to the north of the facility.

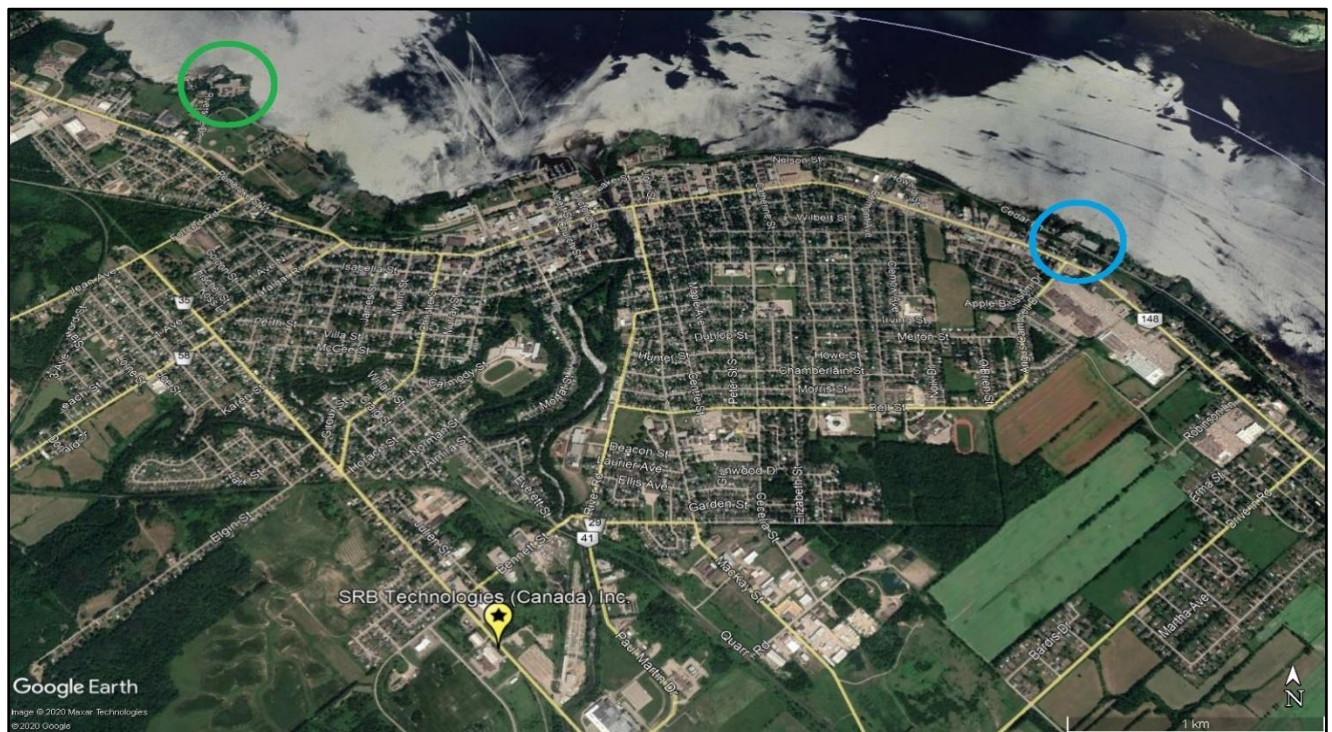

FIGURE 10: LOCATION OF PWTP (GREEN) AND PPCC (BLUE) ON OTTAWA RIVER

2.11 Population

The 2021 population of the City of Pembroke was assessed in the most recent census by Statistics Canada [25] to be 14,364 persons.

Adjacent to the City of Pembroke is Laurentian Valley Township, which is considered a census subdivision of Pembroke. The township lies to the south and west of the SRBT facility. The 2021 population of Laurentian Valley Township was assessed to be 9,450 persons.

The representative 'critical group' of public residents (as derived and discussed in the DRL report from 2021) is located approximately 250-300 metres to the north-northwest of the facility, in the subdivision known as Johnson Meadows.

Public residences are also located to the south-southeast of the facility on the opposite side of the Muskrat River, at distances beginning approximately 500 metres away. The population density is much lower than that of the Johnson Meadows subdivision.

The remaining majority of the population of the City of Pembroke lies northward of the SRBT facility, with the vast majority of residences in excess of 1,000 metres away.

2.12 Environmental Monitoring Program

In order to ensure that the radiological risk to the environment and the public due to licenced operations is accurately measured and quantified in the surrounding environment, SRBT implements a comprehensive Environmental Monitoring Program (EMP).

The design of the EMP was developed in line with the requirements of CSA Standard N288.4-10, *Environmental Monitoring Programs for Class I Nuclear Facilities and Uranium Mines and Mills*. The EMP complies with this standard, and represents a vital element of our licensing basis within the EMS.

The scope of the EMP is defined in terms of:

- The established spatial boundaries within which it is reasonable to expect the operation of SRBT to present a potential measurable environmental impact.
- The exposure pathways that exist between the effluent release points and the representative persons and the environment.
- Selected reference areas which are not exposed to effluent from the facility, and possesses both anthropogenic and natural habitat features that are similar to those of the exposure area.

The primary spatial boundary of the EMP is established as an area encompassed by a circle centred on active ventilation air handling unit stacks, with a radius of 3,500 metres.

The scope of the program includes a comprehensive set of processes relating to the collection and acquisition of various types of samples in the environment, the analysis of those samples for contaminants of interest, and the processing and quality assurance of the data associated with the analyses.

The majority of the physical sampling strategies executed as part of the EMP have been continued in their current form since 2005-06, with several adjustments and improvements being made to the program over time.

There is a significant amount of high-quality, consistent and spatially representative environmental data available to facilitate the completion of an ERA, including concentrations of tritium in air, precipitation, surface waters, residential drinking water, and produce, among others.

2.13 Effluent Monitoring Program

In order to ensure that the radiological risk to the environment and the public due to licenced operations is accurately measured and quantified at the source, SRBT implements a comprehensive Effluent Monitoring Program (EffMP).

The design of the EffMP was undertaken and reviewed using the systemic planning process outlined in Section 6 of the CSA N288.5-11, *Effluent monitoring programs at Class I nuclear facilities and uranium mines and mills*. The program complies with this standard, and forms a critical part of our licensing basis within the EMS.

The scope of the EffMP is defined in terms of:

- The gaseous effluent stream – specifically, the active ventilation systems that service the tritium processing areas of the facility.
- The liquid effluent stream – specifically, those liquids which bear significant quantities of water-soluble tritium that are destined for release through the municipal sewer system.
- The control and maintenance of equipment that is used to support the effective monitoring and measurement of tritium being released via the two effluent streams.
- The administrative controls that are in place to manage these effluents.

The scope of the program includes all processes relating to the collection and acquisition of samples in the gaseous and liquid effluent streams, the analysis of those samples for contaminants of interest, and the processing and quality assurance of the data associated with the analyses.

There is a significant amount of high-quality, consistent and spatially representative effluent data available to facilitate the completion of an ERA, for both gaseous and liquid tritium-bearing effluents.

2.14 Groundwater Monitoring Program

In order to ensure that groundwater resources near the facility are protected, and the risk factors of radionuclide loading are understood, SRBT implements a comprehensive Groundwater Monitoring Program (GMP).

The GMP was designed in accordance with CSA N288.7-15, *Groundwater monitoring programs for Class I nuclear facilities and uranium mines and mills*. The program complies with this standard, and is an important part of our licensing basis within the EMS.

The scope of the GMP is defined in terms of a spatial boundary, as demarcated by the established definition of the 'site' in SRBT's Groundwater Protection Program.

For these purposes, the 'site' is the geographical area upon which the SRBT facility is located, to a radius of 200 metres from the location of the two active ventilation system stacks.

The circle formed by this radius encompasses all current monitoring wells, not including any residential wells used for drinking water (these are sampled as part of the EMP).

The site extends down through the subsurface through to bedrock, to a well depth of 14 metres relative to ground surface.

The GMP scope includes the measurement of the tritium concentration in the groundwater within this boundary, as well as the monitoring well water levels, on a routine frequency.

The program includes processes for preparing the wells for sampling, the actual sampling activity, and the subsequent analysis of the sample material followed by the processing of data, trending of data, and all required reporting activities.

There is a significant amount of high-quality, consistent and spatially representative groundwater data available to facilitate the completion of an ERA, with a groundwater monitoring array that has been sampled monthly for tritium concentration for well over a decade.

2.15 Facility Interactions

In order to manufacture gaseous tritium light sources for tritium filling, several processes are implemented where borosilicate glass is shaped and internally coated with a zinc sulfide-based powder. It is this powder that luminesces when exposed to the low-level beta radiation emitted by the pure tritium gas inside the light once completed.

As a result of these processes, as well as other work that supports these outputs, the facility interacts with the environment in several ways.

Nuclear substance processing operations involve the handling of molecular tritium gas (T_2 or HT) as light sources are filled and sealed. These processes are controlled, and subject to ongoing improvements to limit releases; however, minute quantities of tritium are released into the gaseous and liquid effluent streams, ultimately releasing the material as T_2 /HT and oxidized tritium (HTO) into the environment.

The amount of tritium released, and the nature of the releases, is authorized and limited by our facility operating licence. The releases are assessed and measured both at the source (via the Effluent Monitoring Program), as well as in the surrounding environment (via the Environmental Monitoring and Groundwater Monitoring Programs).

These programs include action levels to ensure that control is continuously maintained, and the potential loss of control events are identified and addressed with effective action.

SRBT reports all releases of tritium on a routine frequency to CNSC staff, as part of an Annual Compliance Report (ACR). Data on these releases are also posted to SRBT's website as part of the Public Information Program.

The anticipated human effects of tritium releases are also assessed at least annually, both from EffMP and EMP data, through a calculation of public dose. Each year it must be demonstrated that the dose imparted to the most-exposed member of the public is less than the regulatory limit of 1 millisievert (mSv) per calendar year.

It must also be shown that these doses are being maintained *as low as reasonably achievable* (ALARA). Public dose data are also included in the ACR, which is posted each year SRBT's website.

The manufacture of light source 'pre-forms' involves limited non-radiological, chemical processes in the manufacturing departments that are performed under negative ventilation.

These processes are conducted pursuant to Certificate of Approval – Air number 5310-4NJQE2, issued by the Ontario Ministry of the Environment and Climate Change. Very

limited quantities of these substances will evaporate or volatilize and make their way through the safety ventilation trains into the environment. As well, a limited number of processes also may introduce diluted quantities of certain chemicals to sewer, under arrangement with the local municipality.

Although SRBT is one of Pembroke's largest manufacturing facilities, there are relatively few, if any, physical stressors that might impact the surrounding environment.

There are very limited or insignificant noise sources, vehicular traffic or road management activities, thermal influences, exhaust particulate, significant artificial night lighting, windows that present bird strike hazards, or physical animal impingement points.

The facility does not directly impact or influence any bodies of water (i.e. for example, use river / lake water for cooling).

3. Human Health Risk Assessment

3.1 Problem Formulation

3.1.1 Receptor Selection and Characterization

Human receptors can be defined in several groups, such as SRBT employees, maintenance contractors and facility visitors, and the members of the local population of the City of Pembroke (i.e. the members of the public).

For the purposes of the Human Health Risk Assessment (HHRA), human receptors that are controlled via SRBT's safety programs, including the *Radiation Safety Program* and our programs for conventional health and safety, are excluded from the scope of the formulated problem statement.

SRBT's *Radiation Safety Program* has continuously maintained safe working conditions for these receptors throughout the history of facility operations. All recorded radiation doses to nuclear energy workers / atomic radiation workers throughout the history of facility operations have fallen well below the limits defined in the *Radiation Protection Regulations*.

In addition, SRBT implements several processes and strategies to ensure that all effective doses are maintained as low as reasonably achievable (ALARA). Any work involving the potential to expose persons to radiological contaminants, or to result in exposure, is controlled and carefully managed – including work of any maintenance contractor support staff. Visitor access controls are maintained to ensure radiological safety while in the facility.

Likewise, exposure to conventional contaminants and physical stressors are assessed and controlled through the effective implementation of SRBT's *Health and Safety Policy* and *Hazard Prevention Program*.

Conventional health and safety data show that for workers and any contractors, the rate of lost time injuries, minor reportable injuries, and near-miss incidents is very low for a manufacturing facility such as SRBT.

SRBT provides a wealth of information on the radiological and conventional safety impacts on these receptors at least annually, through the submission of our Annual Compliance and Performance Report to CNSC staff.

A high level of internal oversight is built into SRBT's Management System focused on the safety programs that protect these receptors, including strategies such as frequent independent internal and external audits, benchmarking, self-assessment requirements, and high-level management review.

Given these conditions, and because it has been continually demonstrated that the level of human exposure is consistently maintained well below safety thresholds during routine operations, these on-site receptors are not included within the scope of the HHRA.

Going forward, the focus of this component of the ERA shall therefore be on the affected members of the general public.

Throughout the history of operations, SRBT has established a set of derived emission / release limits (DEL / DRLs), aimed at ensuring that no member of the general public receives an effective dose greater than that defined in the *Radiation Protection Regulations*.

As part of the DRL, an assessment is made on the radionuclides of concern, expected meteorological conditions, and the geographical distribution and characteristic of members of the public in relation to the source of radiological material being introduced to the surrounding environment.

The DRL defines 'representative persons' (previously known as critical groups) as human receptors that are likely to represent the most impacted people in the surrounding area. By assessing the magnitude of radiological impacts on these 'bounding' groups, the limiting amounts and types of contaminants that may be introduced into the environment can be established.

The relative impacts of exposures can then be derived for any time period based upon a comparison with these limits, ultimately demonstrating the level of risk associated with facility operations on the radiological safety of the general public.

With respect to the types of non-radiological contaminants and physical stressors potentially introduced by the facility, SRBT is confident that the representative persons established in the current DRL are also appropriate for the assessment of these risks and effects, as the effluent pathways are identical (or very similar).

Two additions to the above selected group of receptors have been made for the specific purposes of this ERA. This includes local Indigenous groups, and workers at the Pembroke Pollution Control Centre (PPCC).

Indigenous Groups

There are no known Indigenous groups or communities based within a 3,500 m radius of the SRBT facility (the scoped area of the ERA) that would automatically require consideration as part of the HHRA. SRBT has chosen to include the nearest First Nations community as a specific group considered, for the purposes of this assessment.

The Algonquins of Pikwakanagan First Nation (AOPFN) is situated on the shores of Golden Lake and the Bonnechere River, with the majority of the community located approximately 25-35 km in a south-southeast direction from the facility.

Given the nature of the physical distance between the SRBT facility and the AOPFN community, as well as the fact that the community lies in a non-dominant wind direction in relation to contaminant point sources, it is anticipated that the risks assessed for these receptors will be fully bounded with a considerably conservative margin by those of the representative persons defined in the latest version of the SRBT DRL.

AOPFN knowledge keepers and Guardians have generously contributed important local and Indigenous knowledge on traditional land uses and culturally important sites within the bounds of the scoped area of the ERA to SRBT.

These considerations influence the overall assessment of environmental risks associated with SRBT operations, and provide valuable input to the assessment process, the interpretation of its outputs and any recommendations going forth into the future.

A map depicting the location of the AOPFN is provided in Figure 11.

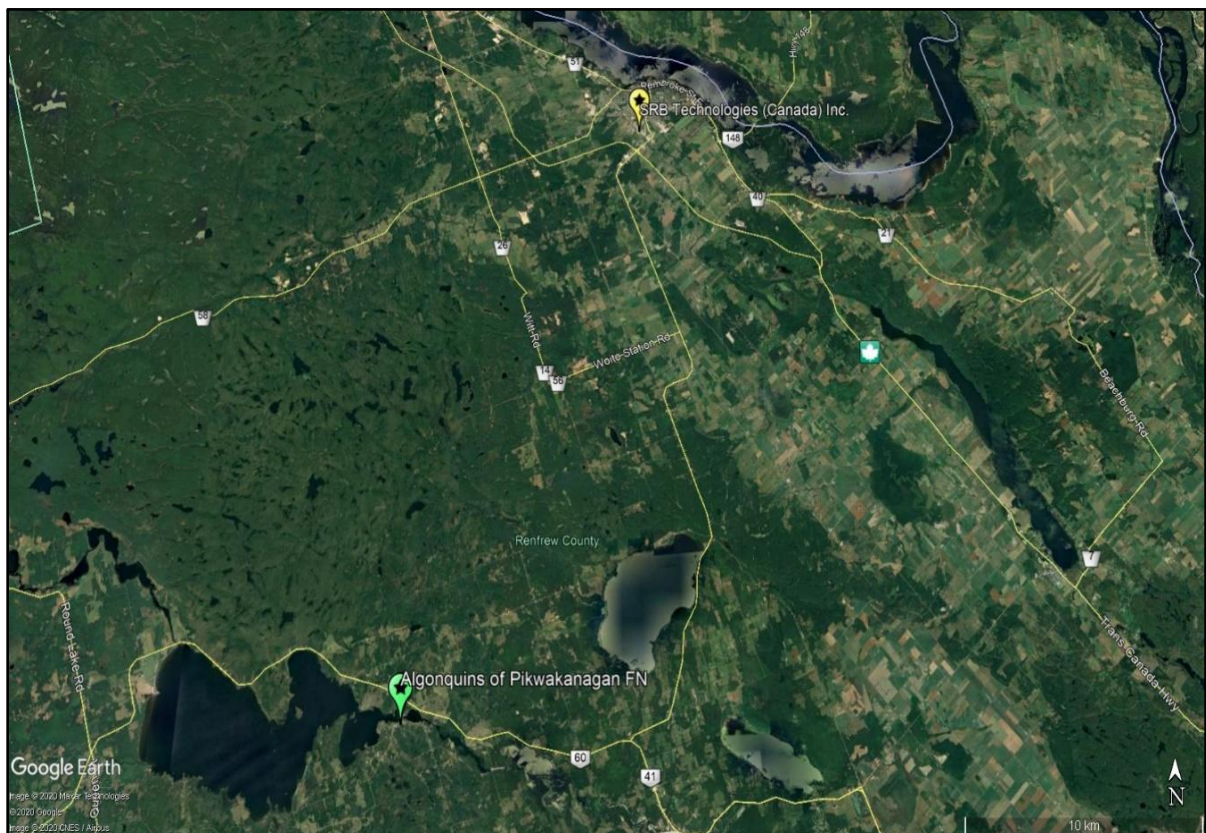

FIGURE 11: LOCATION OF AOPFN RELATIVE TO SRBT

Worker at the Pembroke Pollution Control Centre (PPCC)

An additional potential human receptor that is included in this assessment is a conservatively characterized, maximally-exposed individual working at the PPCC. This receptor is included to fully assess the potential risks arising from COPC introduced into the liquid effluent pathway from the facility.

To summarize, for the purposes of the completion of the HHRA, the receptors selected to be included are:

- The representative persons defined within the 2021 version of SRBT's *Derived Release Limits* document,
- Members of the Algonquins of Pikwakanagan First Nation near Golden Lake, Ontario, and
- A full-time worker at the PPCC.

The different age classes of representative persons previously defined in the DRL are as follows:

- A one-year old infant,
- A ten-year old child,
- An adult resident, and
- An adult worker.

To summarize, representative persons are characterized as living in Johnson Meadows subdivision, residing there for 100% of the year, exhibiting breathing rates in the 95th percentile, and having similarly conservative consumption habits of local produce and drinking water, as well as time spent bathing/swimming.

In the case of the adult worker, 23.7% of their time (i.e. 40 hours per week) is spent at work, with an elevated breathing rate, either at a workplace in the same industrial building as the SRBT facility, or at the PPCC facility in the case of the PPCC worker.

A tabular summary of these characteristics is provided in Section 3.2.2.

3.1.2 Selection of Stressors

The SRBT facility has been in operation for over three decades, with few changes to processes which may present a risk to humans. Generally, the methods implemented when SRBT manufactures tritium light sources have remained consistent throughout the operational history of the facility.

This is not to say that there have not been changes and improvements in the magnitude of stressors that have been released over these years – in fact, SRBT has continuously made efforts to reduce facility-related impacts, especially with respect to the release of tritium.

In order to select the associated stressors that are carried forward into the assessment, a facility-wide review of all manufacturing processes was completed, combined with a desktop review of information pertaining to these processes through the years.

Based on this review, a comprehensive list of all potential radiological, chemical, and physical stressors that may influence human health risk by the facility is included in Appendices A and B.

The Appendices outline selected screening criteria, and notes describing any details on the nature of the stressor, the basis of the screening criteria, and the levels of exposure used for the comparison.

There are several chemical stressors that are listed that are representative components of products that are used for certain processes, or are known to be a potential fugitive emission from the process.

For example, the chemicals listed as part of potential stressors associated with silk screening activities are originally derived from published Safety Data Sheets for those products. As another example, the list of chemicals that are associated with plastic injection molding are the potential volatile species that arise with this process.

This results in a significantly longer list of chemical species being screened than would be expected if one were only assessing those chemical products that are used routinely at the facility.

In order to select the key stressors and contaminants of potential concern (COPC) to carry forward through to the higher levels of the HHRA, the following process was undertaken.

The three significant forms of tritium (oxide, molecular, organically bound) were automatically carried forward to a preliminary quantitative assessment, as they are understood to be relevant and significant given the nature of the operations.

For physical stressors, a general assessment was made with appropriate measurements (where feasible) in order to determine a rational level of further assessment if warranted.

For conventional / chemical COPC, release rates and quantities were derived through usage data and effluent flow rates. Where available, data from past assessments have been cited, contingent on the processes having remained relatively unchanged since the initial assessment was completed.

Comparisons to available industrial hygiene limits and/or most restrictive published emission limits were made where available. Any COPC exceeding the selected screening criterion being carried forward to a more detailed quantitative assessment.

Where possible, established limits from the Government of Ontario were used; absent this, national limits were researched.

Where a lack of published national or provincial government guidelines was found, research into limits used by other jurisdictions and/or international environmental health organizations was undertaken to determine a reasonably conservative screening criterion.

The process of determining appropriate screening benchmark values for conventional or chemical COPC is illustrated in Figure 12.

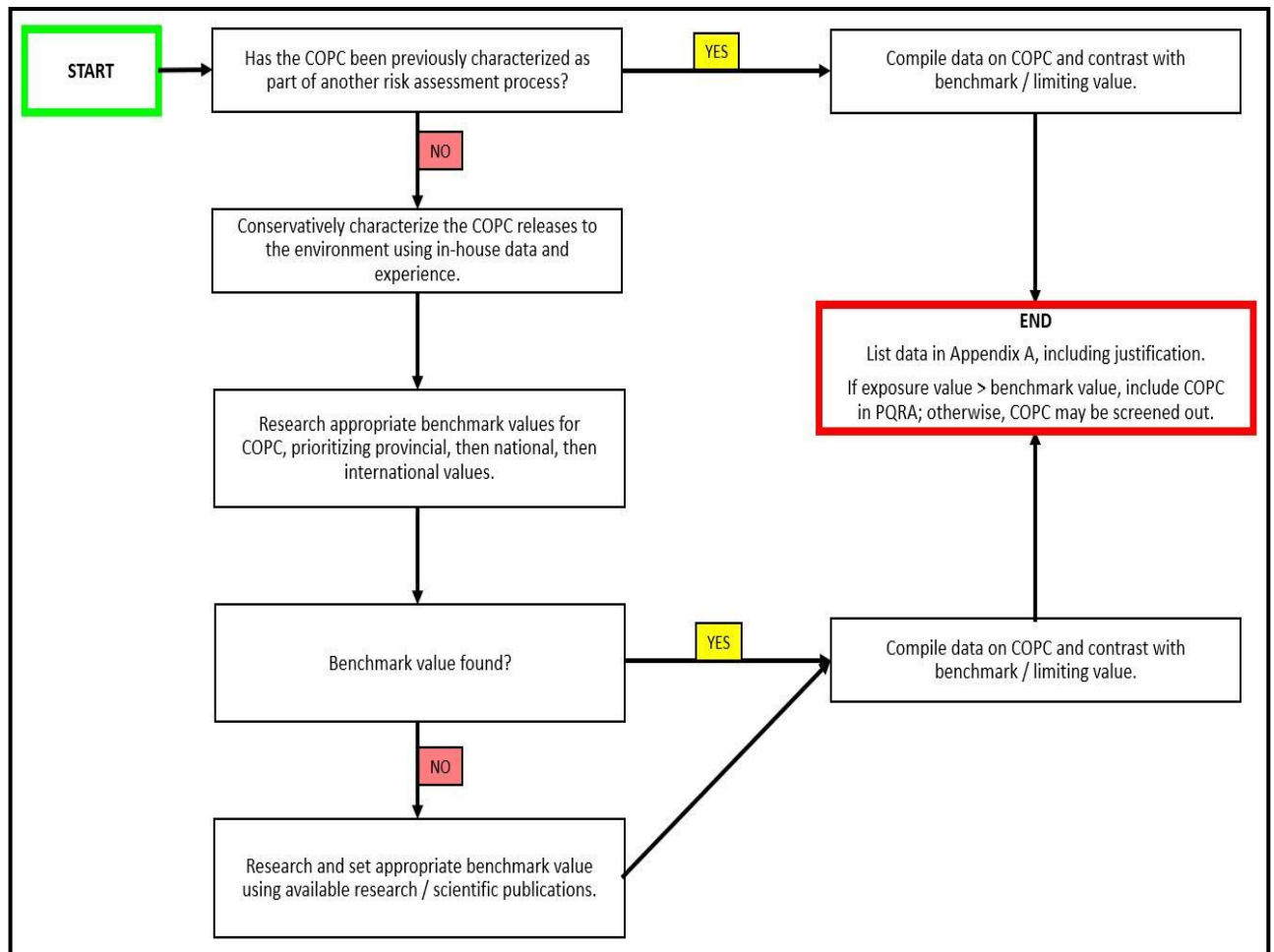

FIGURE 12: BENCHMARK VALUE DETERMINATION PROCESS

None of the conventional COPC exceeded selected screening criteria, and as such, they are taken to not pose a level of risk that warrants further assessment. No preliminary quantitative analysis of human health risks associated with these COPC has been performed.

Noise was carried forward to the risk assessment as the sole physical stressor of concern.

As noted earlier, tritium in various forms is the sole radiological contaminant that has been carried forward into a Tier 2 preliminary quantitative risk assessment for human health risk, despite the fact that the most restrictive calculated human exposure in the last several years fell well short of the selected screening criterion of $> 10 \mu\text{Sv/a}$.

The calculated annual dose to the most exposed member of the public for the past several years is provided in Table 6.

YEAR	CALCULATED PUBLIC DOSE (μSv)
2010	5.015
2011	5.031
2012	4.346
2013	6.774
2014	6.738
2015	6.840
2016	4.579
2017	3.349
2018	3.792
2019	2.151
2020	2.374
2021	1.991
2022	2.002
2023	2.251
2024	2.630
2025	1.476

TABLE 6: PUBLIC DOSE (2010 – 2025)

The decision to conduct a conservative, quantitative assessment considers the significant public and regulatory interest in tritium as the only radionuclide released from the facility, and as the core focus of the EMS. The results of this initial analysis of tritium-related risk also serves as a baseline for comparison in future ERA iterations.

The outcomes of this initial screening assessment process described here are detailed in Appendix A, which includes tables that list each potential COPC or stressor, the selected benchmark values, and the facility-related environmental and effluent concentrations that were measured or derived.

3.1.3 Selection of Exposure Pathways

The release mechanisms for those COPC identified through the initial screening process are typically dominated by facility emissions to air, with some limited potential exposure through liquid effluent.

Potential exposure pathways for both radiological and non-radiological COPC include:

- Inhalation
- Ingestion of water containing contaminant
- Ingestion of foodstuffs containing contaminant
- Ingestion of dust / soils
- Dermal absorption – gaseous
- Dermal absorption – liquid

For tritium, exposure to dust and soil via ingestion and dermal absorption have been previously shown to be trivial as part of the 2021 DRL assessment process.

Dermal absorption of tritium in air is possible, but this exposure pathway is implicitly accounted for in the calculation of inhalation exposures (see Section 3.2.2).

Inhalation and ingestion of food and water are all known to be potentially significant pathways for tritium, and potential exposures along these pathways are assessed for the selected receptors as part of this assessment.

For non-radiological gaseous COPC, very similar pathways are likely to dominate human exposures, although there may be some differences and additional considerations required, depending on the nature of the material. Where required, specific nuances will be discussed and processed individually.

Although currently understood to present a very low risk, a final human exposure pathway is the potential for human – COPC interactions associated with facility liquid effluent, in particular at the PPCC.

Exposure to noise assumes a pathway of effect at the boundary of the area controlled by the facility.

3.1.4 Human Health Conceptual Models

For HTO and molecular tritium gas released to atmosphere, and the selected receptors, the current set of accepted human exposure pathways is well described in the Derived Release Limits guidance document [24]. These pathways are graphically represented here, as Figures 13 and 14.

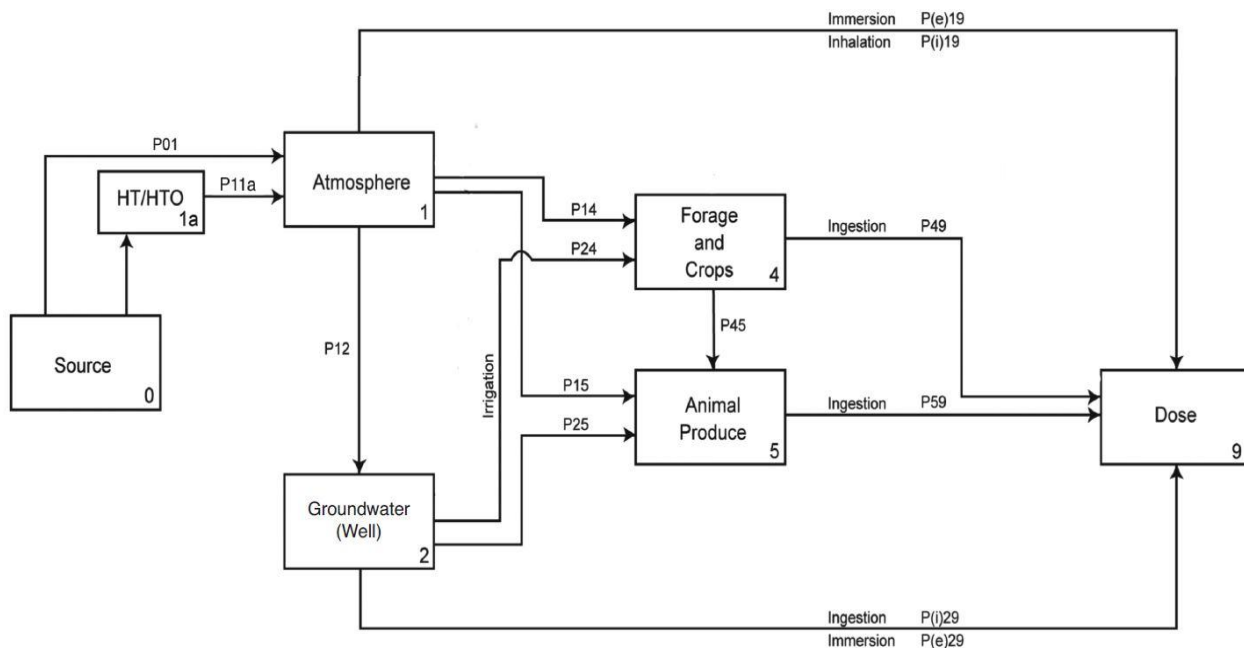

FIGURE 13: HUMAN EXPOSURE PATHWAYS (HTO/T₂, GASEOUS SOURCES)

A similar conceptual model is applied to account for exposures to all liquid effluent-borne COPC at the PPCC.

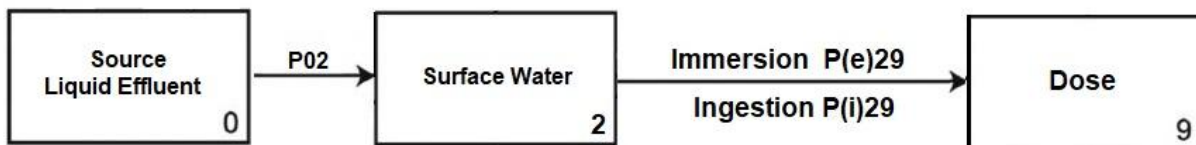

FIGURE 14: HUMAN EXPOSURE PATHWAYS (HTO/T₂, LIQUID SOURCES)

For non-radiological gaseous COPC, very similar gaseous pathways are likely to dominate human exposures, although there may be some differences and additional considerations required, depending on the nature of the material. As required, specific nuances are discussed and processed individually.

3.1.5 Problem Formulation – Uncertainties

Each major aspect of the process of problem formulation includes some uncertainty.

In regards to receptor selection and characterization, detailed surveys of community composition and characteristics have not recently been completed in the vicinity of the SRBT facility. As such, various aspects of potential relevance to the HHRA are not known with certainty (age class distribution, dietary habits, occupancy rates, drinking water sources, etc.).

In absence of this detailed understanding, the "representative person" concept has been applied, establishing a series of age classes that effectively represent the full age spectrum. For each age class, 95th percentile values of various key human characteristics are applied (ingestion rates for food and water, inhalation rates, etc.).

The assigned characteristics are not expected to be representative of any actual member of the public, but are expected to conservatively represent the actual range of those characteristics as they may exist in the public residing near the facility.

In the selection of stressors, potential releases to the environment of many substances found at the facility are not subject to direct monitoring, and there is uncertainty in regard to which substances may actually be released and in what quantity. In the screening on non-radiological COPCs, this uncertainty is addressed by applying the conservative assumption that all substances might be released to the environment.

The quantity of release conservatively assumes that the total known amount of a given substance is released and leads to exposure at the point of release without dilution or attenuation.

With these very conservative assumptions, any uncertainties regarding COPC emissions are not expected to result in the exclusion of any COPC that should be considered in the HHRA.

In regard to the conceptual model, there is also some uncertainty as to which combination of exposure pathways may be relevant to the nearby members of the public. The HHRA conceptual model has been developed to include all potentially relevant pathways that are understood to be potentially significant in regard to human exposure and dose associated with tritium and other possible COPCs.

The selected pathways include all those that are identified in CSA Standard N288.1. Under this approach, the conceptual model will not exclude pathways that have any potential to be relevant and potentially significant.

Overall, the conceptual models and pathways of exposure are considered to be adequately representative of the vast majority of potential human-COPC interactions. The selected parameters are expected to result in conservative estimates of human health risks associated with SRBT facility operations.

3.2 Exposure Assessment

3.2.1 Description of Exposure Locations, Duration and Frequency

For the group of representative persons (formerly known as “critical group” members in the DRL / DEL), the site of residential exposure is located approximately 250 metres of the facility in the northwest direction, in the Johnson Meadows subdivision. With respect to human population, this location has been identified as the most exposed location in the area surrounding the facility.

For the 1-year old child, 10-year old child, and adult residents, the exposures to COPC occurs 100% of the time in this location, unless a more restrictive pathway can be justified.

For the adult worker, exposure occurs for 2,000 hours per calendar year at their place of employment, taken to be another business in the same building as the SRBT facility, while the remainder of the year is spent at the same location as that defined for representative persons. Note that this is a very conservative characterization of this person, and that there is no known individual who approaches these characteristics.

The worker exposed at the PPCC is similar to the adult worker as defined in the group of representative persons, except that instead of working in the same building as the SRBT facility, they work an identical number of hours at the PPCC, with correspondingly conservative exposure conditions.

Workers are also characterized as having an elevated breathing rate while at work, in accordance with guidance in ICRP 119.

For noise effects, exposure occurs at the boundary of the area controlled by the facility. A duration of eight hours in a day (i.e. a typical workday length) is used at peak noise to assess the risk to human health.

3.2.2 Exposure and Dose Calculations – Radiological

For the purposes of the ERA, radiological dose calculations closely follow the guidance and requirements outlined in CSA standard N288.1-14, as well as the methodology historically applied when calculating annual public dose as part of SRBT compliance reporting. Tritium in its various forms is the only significant radiological contaminant of concern.

For the persons defined by the representative groups, a conservative methodology of calculating the potential doses has been selected in order to account for uncertainties in the assessment.

The methodology is as follows:

- For each of the exposure inputs described by the conceptual model, select the highest validated individual EMP measurement of the contaminant concentration from the last eleven years of operations (2015-2025 calendar years), at the point of impingement / exposure.
- Multiply this value by a factor of 2 in order to add additional conservatism, and account for potential increases or variations in facility production rates in the future.
- Apply the conservative intake rates for air, water and food as applicable for each representative person, as described in N288.1-14 (or otherwise justified), in order to derive the effective dose over a given year.
- Add all effective doses together for a total calculated potential effective dose to the representative person.

Table 7 summarizes the annualized exposure factors applied for each type of receptor in the representative group.

EXPOSURE FACTOR	UNITS	INFANT (1 YR)	CHILD (10 YR)	ADULT
Inhalation rate	m ³ /a	2,740	7,850	8,400
Worker inhalation rate	m ³ /a	-	-	10,512
Drinking water intake rate	L/a	306	482	1,081
Produce intake rate – commercial	kg/a	87	186	289
Produce intake rate – residential	kg/a	37	80	124
Animal produce intake rate (milk)	kg/a	340	320	189

TABLE 7: EXPOSURE FACTORS - HHRA

All listed factors are rounded to the nearest unit, and are based upon guidance and requirements outlined in the CSA N288.1-14 standard, save for the worker inhalation rate, which is derived from ICRP 119 (where committed effective dose coefficients are noted as being based on a breathing rate of 1.2 m³/h over an 8 hour work day).

Produce intake rates are derived based upon a distribution of 30% of consumed produce obtained from residential gardens, while 70% is obtained from commercially available local sources.

These fractions are based upon a site-specific survey previously completed by SRBT, which determined that the home-grown fraction of plant products consumed by residents in the surrounding area was approximately 30% - a slightly higher value than that recommended in the generic guidance of N288.1-14 (20-25%).

Table 8 details the effective dose coefficients applied, as described by CSA standard N288.1-14, for each of the three types of representative persons:

AGE GROUP	EFFECTIVE DOSE COEFFICIENT – INHALATION (HTO) (μSv/Bq)	EFFECTIVE DOSE COEFFICIENT – INGESTION (HTO) (μSv/Bq)	EFFECTIVE DOSE COEFFICIENT – INGESTION (OBT) (μSv/Bq)	EFFECTIVE DOSE COEFFICIENT – IMMERSION (HTO) (μSv/a per Bq/L)
Infant	8.0E-5	5.3E-5	1.3E-4	5.61E-5
Child	3.8E-5	2.5E-5	6.3E-5	2.15E-4
Adult	3.0E-5	2.0E-5	4.6E-5	2.58E-4

TABLE 8: EFFECTIVE DOSE COEFFICIENTS

NOTE: The dose coefficients listed for inhalation implicitly include skin absorption, as per Table C.1 of N288.1-14.

Table 9 details the exposure model input parameters for residents and workers located in Pembroke, as described above.

Five input parameters have increased from the previous assessment based on measurements performed since 2019:

- Air concentration, occupational (HTO)
- Air concentration, Pembroke Pollution Control Centre (PPCC)
- Residential produce (HTO)
- Commercial produce (OBT)
- Animal produce – milk (HTO)

As well, the input parameter for OBT in milk has been established through sampling, as opposed to the derived value applied in the previous version of the ERA. Samples of local milk have been analyzed for OBT content annually since 2022.

INPUT PARAMETER	UNITS	MAX. ELEVEN YEAR MEASUREMENT	APPLIED INPUT VALUE
Air concentration, residential (HTO)	Bq/m ³	24.40 (Nov. 2015, NW250)	49
Air concentration, occupational (HTO)	Bq/m ³	19.46 (Nov. 2024, PAS 2)	39
Drinking water (HTO)	Bq/L	232 (RW-8, Nov. 2015)	464
Residential produce (HTO)	Bq/kg	461 (2023, green onion)	922
Residential produce (OBT)	Bq/kg	13 (2016, carrot)	26
Commercial produce (HTO)	Bq/kg	12 (2019, cucumber)	24
Commercial produce (OBT)	Bq/kg	4 (2021, tomato)	8
Animal produce – milk (HTO)	Bq/kg	7.76 (Sep. 2024)	16
Animal produce – milk (OBT)	Bq/kg	8.73 (Sep. 2023)	18
Air concentration, PPCC (HTO)	Bq/m ³	3.09 (2022)	7
Immersion liquid concentration, PPCC (HTO)	Bq/L	75 (Sep. 2022)	150

TABLE 9: INPUT PARAMETERS - HHRA

Appendix B details the complete set of inputs and calculations for deriving the effective dose of each representative person assessed in accordance with the described methodology.

The tritium air concentration at the PPCC has been established over the past five years by measurement via passive air sampling over several weeks each year. All sample results have measured lower than the minimum detectable activity of the sampling and analysis process (ranging between 0.28 – 0.41 Bq/m³), except for the measurement in 2022, with a maximum assessment of 3.09 Bq/m³.

As well, the maximum value of tritium in liquids obtained from PPCC sludge cake sampling and analysis (75 Bq/L) has been applied for a conservative estimate of

the effective dose associated with immersion at work, due to the nature of the work taking place at that facility.

With respect to the Algonquin of Pikwakanagan First Nation (AOPFN) community, refer to the previous version of this assessment for a fulsome review of the sampling activities undertaken in the Pikwakanagan community in 2020.

Since that time, SRBT has performed additional collaborative campaigns of environmental sampling in Pikwakanagan and the surrounding areas:

- In 2021, a sampling campaign was conducted that repeated sample acquisition for five plant types identified as holding cultural significance, including ironwood tree bark, mullein, red cedar, raspberry leaves, and sumac berries. Sampling also included shoreline water from Golden Lake.
- In 2022, shoreline water samples were again obtained from Golden Lake. In addition, eight samples of plants of cultural or economic importance were obtained in the land between the SRBT facility and the AOPFN community, at various distances.
- In 2023, samples of plants of cultural or economic importance to the AOPFN community were sampled in the immediate areas around the SRBT facility (i.e. less than one kilometre away).
- In 2024, a sampling campaign was conducted within the community of Pikwakanagan, supported by members of the AOPFN. The five sample types monitored in the previous years were again included as part of this campaign. In addition, a sample of recently harvested moose meat was provided, which had recently been obtained outside of the community, in Algonquin Park. Samples of lake, creek and groundwater were also obtained and analyzed.

A compilation of AOPFN-related environmental sampling data obtained between 2020-2025 is presented in Table 10.

Results obtained to date have been significantly lower than those used in the calculation of risk to representative groups nearer the facility; as such, the quantified risk to members of this community is virtually certain to be far less than that established for nearby representative persons. Quantitative assessments of associated human health risks have been shared with AOPFN on a case-by-case basis as part of this special set of sampling campaigns.

Year	Month	Day	Sample Type	Approximate Location	Result	Units of Measure	Free-water tritium (FWT) or Organically-bound tritium (OBT)
2020	10	2	Ironwood Bark	45°33'44.6"N 77°15'55.3"W	9	Bq/kg (fresh weight)	FWT
2020	10	2	Red Cedar	45°33'44.6"N 77°15'55.3"W	12	Bq/kg (fresh weight)	FWT
2020	10	2	Sumac	45°33'44.6"N 77°15'55.3"W	11	Bq/kg (fresh weight)	FWT
2020	10	2	Mullein	45°33'44.6"N 77°15'55.3"W	12	Bq/kg (fresh weight)	FWT
2020	10	2	Raspberry Leaf	45°33'44.6"N 77°15'55.3"W	42	Bq/kg (fresh weight)	FWT
2020	11	2	Precipitation	45°34'39.1"N 77°15'04.9"W	15	Bq/L	FWT
2020	11	2	Air sample	45°34'39.1"N 77°15'04.9"W	< 0.70 (MDA)	Bq/m ³	FWT
2020	12	2	Precipitation	45°34'39.1"N 77°15'04.9"W	15	Bq/L	FWT
2020	12	2	Air sample	45°34'39.1"N 77°15'04.9"W	< 0.76 (MDA)	Bq/m ³	FWT
2021	7	21	Water - Golden Lake	45°34'39.1"N 77°15'04.9"W	2	Bq/L	FWT
2021	7	21	Ironwood Bark	45°33'44.6"N 77°15'55.3"W	6	Bq/kg (fresh weight)	FWT
2021	7	21	Red Cedar	45°33'44.6"N 77°15'55.3"W	4	Bq/kg (fresh weight)	FWT
2021	7	21	Sumac	45°33'44.6"N 77°15'55.3"W	2	Bq/kg (fresh weight)	FWT
2021	7	21	Mullein	45°33'44.6"N 77°15'55.3"W	3	Bq/kg (fresh weight)	FWT
2021	7	21	Raspberry Leaf	45°33'44.6"N 77°15'55.3"W	6	Bq/kg (fresh weight)	FWT
2021	7	21	Ironwood Bark	45°33'44.6"N 77°15'55.3"W	9	Bq/kg (fresh weight)	OBT
2021	7	21	Red Cedar	45°33'44.6"N 77°15'55.3"W	9	Bq/kg (fresh weight)	OBT
2021	7	21	Sumac	45°33'44.6"N 77°15'55.3"W	14	Bq/kg (fresh weight)	OBT
2021	7	21	Mullein	45°33'44.6"N 77°15'55.3"W	8	Bq/kg (fresh weight)	OBT
2021	7	21	Raspberry Leaf	45°33'44.6"N 77°15'55.3"W	30	Bq/kg (fresh weight)	OBT
2022	7	26	Water - Golden Lake	45°34'39.1"N 77°15'04.9"W	3	Bq/L	FWT
2022	7	26	Mullein	45°47'53.2"N 77°07'15.7"W	6	Bq/kg (fresh weight)	FWT
2022	7	26	Chokecherry	45°47'22.1"N 77°07'47.1"W	3	Bq/kg (fresh weight)	FWT
2022	7	26	Bullrush	45°45'44.8"N 77°09'10.1"W	3	Bq/kg (fresh weight)	FWT
2022	7	26	Ferns	45°43'03.4"N 77°10'49.5"W	2	Bq/kg (fresh weight)	FWT
2022	7	26	Sumac Berry	45°41'16.9"N 77°12'29.0"W	2	Bq/kg (fresh weight)	FWT
2022	7	26	Raspberry Leaf	45°38'35.4"N 77°13'41.5"W	3	Bq/kg (fresh weight)	FWT
2022	7	26	Sumac Berry	45°36'05.7"N 77°13'60.0"W	2	Bq/kg (fresh weight)	FWT
2022	7	26	Red Cedar	45°34'39.8"N 77°15'04.6"W	2	Bq/kg (fresh weight)	FWT
2023	8	3	Sumac Berry	45°48'06.4"N 77°05'32.1"W	6	Bq/kg (fresh weight)	FWT
2023	8	3	Sumac Berry	45°48'00.4"N, 77°06'44.1"W	23	Bq/kg (fresh weight)	FWT
2023	8	3	Sumac Berry	45°49'46.1"N 77°07'51.4"W	7	Bq/kg (fresh weight)	FWT
2023	8	3	Sumac Berry	45°48'06.4"N 77°05'32.1"W	2	Bq/kg (fresh weight)	OBT
2023	8	3	Sumac Berry	45°48'00.4"N, 77°06'44.1"W	13	Bq/kg (fresh weight)	OBT
2023	8	3	Sumac Berry	45°49'46.1"N 77°07'51.4"W	11	Bq/kg (fresh weight)	OBT
2024	11	1	Water - Golden Lake	45°34'03.26"N 77°15'57.54"W	2	Bq/L	FWT
2024	11	1	Creek water	45°33'47.75"N 77°15'21.81"W	2	Bq/L	FWT
2024	11	1	Groundwater	45°33'47.22"N 77°15'39.88"W	< 1.14 (MDA)	Bq/L	FWT
2024	11	1	Raspberry Leaf	45°33'47.74"N 77°15'28.55"W	3	Bq/kg (fresh weight)	FWT
2024	11	1	Ironwood Bark	45°33'50.922"N 77°15'31.11"W	1	Bq/kg (fresh weight)	FWT
2024	11	1	Red Cedar	45°33'59.50"N 77°16'00.04"W	2	Bq/kg (fresh weight)	FWT
2024	11	1	Mullein	45°34'00.78"N 77°15'59.24"W	2	Bq/kg (fresh weight)	FWT
2024	11	1	Sumac Berry	45°34'03.26"N 77°15'57.54"W	1	Bq/kg (fresh weight)	FWT
2024	11	1	Moose Meat	Algonquin Park Basin Depot	4	Bq/kg (fresh weight)	FWT
2024	11	1	Sumac Berry	45°34'03.26"N 77°15'57.54"W	2	Bq/kg (fresh weight)	OBT
2024	11	1	Moose Meat	Algonquin Park Basin Depot	1	Bq/kg (fresh weight)	OBT

TABLE 10: AOPFN SAMPLE RESULTS

3.2.3 Exposure and Dose Calculations – Non-radiological

All non-radiological COPC were assessed using a screening process, as described in section 3.1.2.

In no instance did the conservatively projected contaminant concentrations at the point of exposure / impingement exceed the selected screening criteria.

As a result, no exposure or dose calculations for these types of contaminants are necessary.

3.2.4 Exposure Calculations - Physical

The sole physical stressor that exceeded the selected screening criteria is noise. All other potential physical stressors were assessed using a screening process, as described in section 3.1.2, and screened out as insignificant, including artificial night lighting and vehicular traffic.

For noise, the Class 2 Exclusionary Sound Limits defined in Table B-2 of the Ontario Ministry of Environment and Climate Change's *Environmental Noise Guideline – Stationary and Transportation Sources – Approval and Planning (NPC-300)* were used as screening criteria.

An assessment of the levels of sound surrounding the facility was completed over a 24 hour period between September 10-11, 2020. Six points on the boundary of the facility were selected (see Figure 15) where noise emanating from the facility could be impacting humans. These remain representative of the level of noise today as there have been no facility modifications which have introduced new sound hazards outside of the facility.

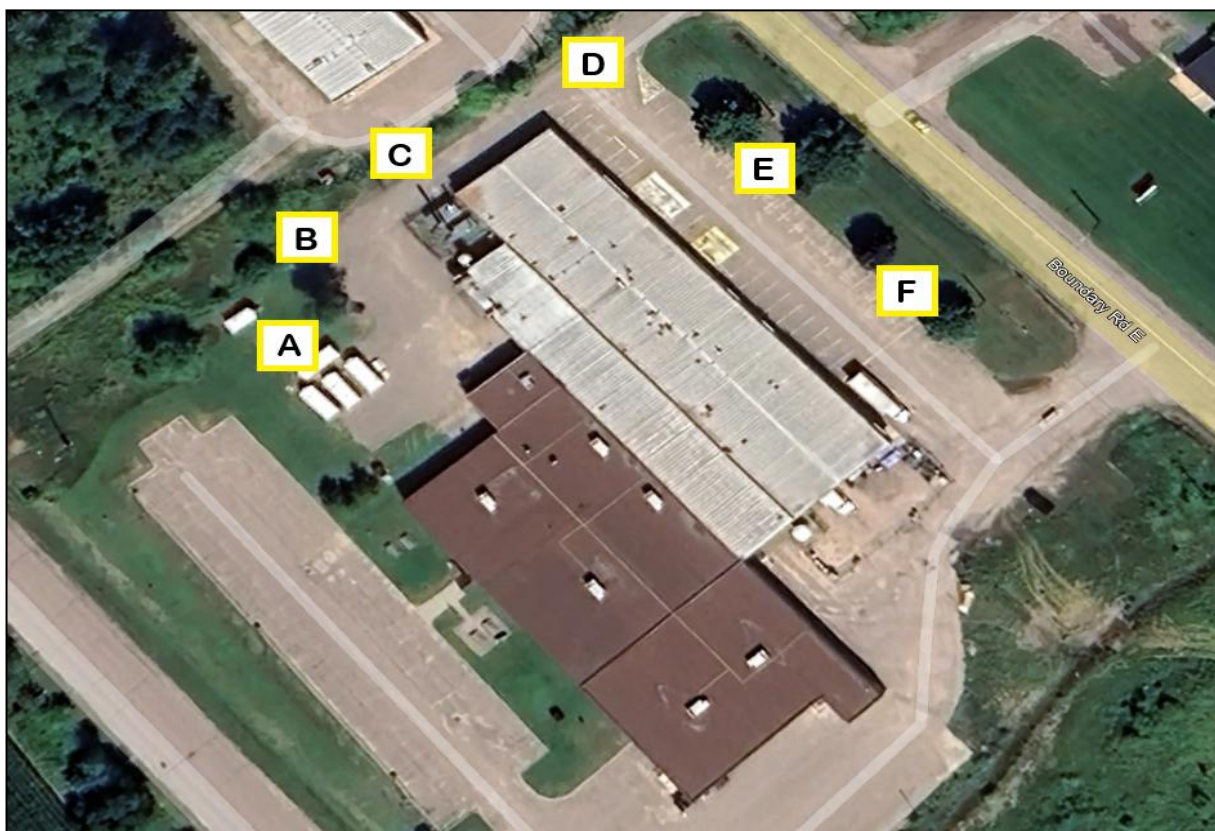

FIGURE 15: NOISE MEASUREMENT LOCATIONS

Measurements were taken at five different times of day. The data are summarized in Table 11.

POSITION	Sep. 10, 2020 0730h	Sep. 10, 2020 1300h	Sep. 10, 2020 1830h	Sep. 10, 2020 2100h	Sep. 11, 2020 0300h	AVERAGE
Position A	49 dB	51 dB	52 dB	56 dB	55 dB	52.6 dB
Position B	54 dB	55 dB	56 dB	56 dB	55 dB	55.2 dB
Position C	55 dB	55 dB	56 dB	55 dB	54 dB	55.0 dB
Position D	52 dB	52 dB	53 dB	48 dB	52 dB	51.4 dB
Position E	51 dB	49 dB	47 dB	49 dB	48 dB	48.8 dB
Position F	48 dB	52 dB	51 dB	40 dB	38 dB	45.8 dB
Average	51.5 dB	52.3 dB	52.5 dB	50.7 dB	50.3 dB	51.5 dB

TABLE 11: NOISE MEASUREMENT DATA

As a comparative assessment of the relative risk to any human who may be exposed to these levels of sound that may originate from the facility, for occupational purposes, the schedule to Section 7.4 of Part VII of the *Canada Occupational Health and Safety Regulations* notes that no worker shall be exposed to a sound level of more than 87 dB over any eight hour period.

The highest recorded noise level that can be confidently attributed to the SRBT facility at the perimeter of the area of control is 56 dB. As the decibel scale is logarithmic, this level of noise is on the order of one thousand times less than the noted occupational limit.

There are periods and locations where the recorded sound levels fall below the Class 2 limits defined in NPC-300, and site observations indicate that the noise being measured at these locations is very likely to be dominated by traffic and noise from other nearby facilities.

The measured noise levels are well within reasonably acceptable noise levels commonly associated with a semi-urban / business park environment. There is no recorded instance where a member of the public registered a complaint or remark about the level of noise emanating from the SRBT facility.

These measurements and observations result in the conclusion that noise from the SRBT facility is very unlikely to have a direct, adverse effect on any nearby human receptors at any time.

3.2.5 Uncertainties in Exposure Assessment

Traditionally, SRBT has calculated radiological dose to the persons outside of the facility using two distinct methods.

The first is based upon the measurements of tritium in effluents at the point of release, which are used as inputs to modeling of the subsequent behaviour of this material in the environment, as defined in the DRL document. This method of calculation uses a 'pathways' approach coupled with validated dispersion modelling, to estimate the exposure rates of humans to tritium.

The second method uses conservatively selected direct measurements in the environment from the Environmental Monitoring Program in lieu of modelled estimates.

The exposure levels generated through both of these methods are then used as inputs into dose calculations. The characteristics of human receptors are governed by the guidance contained in CSA standard N288.1-14, *Guidelines for calculating derived release limits for radioactive material in airborne and liquid effluents for normal operation of nuclear facilities*.

The application of two traditional methods of calculating dose to individual human receptors lends confidence to both methods when the results are similar. A review of previous annual compliance reports shows this to be the case. As such, some uncertainty in the magnitude of calculated doses is addressed.

The current assessment relies on conservatively derived assumptions on the behaviours and characteristics of the human receptors. Where possible, 95th percentile characteristics are conservatively applied in calculating radiological doses, with the understanding that receptors are likely to experience actual rates of exposure that are lower than estimated on this basis.

There is also uncertainty in the actual concentrations of tritium in the environment to which the human population is exposed; monitoring data are only a 'snapshot' in time, and are not perfectly representative of the average concentrations experienced.

The scientific literature also acknowledges significant variability in tritium concentrations in produce on a day-to-day basis, due to the complexity of plant biological processes and the impact of changing meteorological conditions.

The selection and subsequent doubling of maximum measures of tritium in produce to quantify exposure is a conservatism that has been applied, in recognition of this uncertainty.

Overall, the uncertainties in the exposure assessment are not expected to result in any underestimation in the calculation of human doses, largely as a result of the various conservatisms applied.

Actual exposures to any real person in the surrounding area are expected to be significantly lower than the exposures conservatively estimated for the purposes of this ERA.

3.3 Risk Characterization

In order to characterize the cumulative risks presented to human receptors by all COPC stemming from SRBT facility operation, the radiological and non-radiological contaminants and physical stressors first must be considered individually.

3.3.1 Radiological Risk Characterization

Radiological risks arise solely due to the release of tritium in both oxide and molecular gas form. The exposure assessments performed as part of this ERA, as well as those routinely completed as part of the annual cycle of compliance reporting, have clearly and consistently demonstrated a low level of risk to the public.

These assessments are based on deriving risks through both effluent monitoring data, as well as through environmental measurements of tritium in the surrounding environment.

Based on the current level of operations, the regulatory dose limit of 1 mSv/a is extremely unlikely to be approached under normal operations, with a significant margin of safety.

Public dose estimates for the critical receptor groups have consistently been lower than 10 μ Sv/a (i.e. <1% of the regulatory limit) for the past decade of facility operations, and are not expected to rise past this level even if facility production rates should increase significantly. No discernable human health effects are foreseen due to exposure of members of the public to radiological releases from SRBT.

The effective doses derived as part of the HHRA are extremely conservative, and are highly unlikely to be representative of any real individual or group.

Tritium releases from the facility during normal operations are adequately measured, characterized, and controlled; nevertheless, SRBT continues to commit to reducing tritium emissions wherever feasible, consistent with the ALARA philosophy.

3.3.2 Non-radiological Risk Characterization

All non-radiological chemical stressors that are potentially associated with the facility were assessed as part of the screening process.

In each case, it was shown that the individual amounts / concentrations of these substances at the point of release were lower than the conservatively selected screening criteria.

As such, the amounts / concentrations of non-radiological chemical COPC are deemed to be lower than any level that might pose any risk to human health.

3.3.3 Physical Risk Characterization

With respect to noise levels, although there are periods and locations where the recorded sound levels are marginally above the Class 2 limits defined in NPC-300, site observations indicate that the noise being measured at these locations is very likely to be dominated by traffic and noise from other nearby facilities.

The measured noise levels are well within reasonably acceptable noise levels commonly associated with a semi-urban / business park environment.

Noise from the SRBT facility is very unlikely to pose a direct, adverse effect on any nearby human receptors at any time.

All other physical stressors that are potentially associated with the facility were assessed as part of the screening process, and determined to be far too low to pose any significant impact to human health. This includes artificial night lighting and vehicular traffic.

Based on this assessment, the potential exposure of human receptors to physical stressors is not expected to cause a measurable adverse effect on human health.

3.3.4 Cumulative Risk Characterization

Based on the results of the above characterizations, it can be stated with a high degree of confidence that the cumulative risks to human health posed by the SRBT facility are acceptably low, and are expected to remain acceptably low for the foreseeable future.

This includes all radiological, non-radiological and physical contaminants and stressors.

3.3.5 Uncertainties in Human Health Risk Assessment

Compounded with the uncertainties in the exposure assessment, the uncertainty in the assessed risk presented to humans is also discussed here.

The dose conversion factors for tritium applied for the purposes of the HHRA are obtained from Table C.1 of CSA N288.1-14. These factors are acknowledged as higher than those recommended by the ICRP (as noted in Note 1 of the table, and through to the referenced document COG-06-3090-R2-1, *Derived Release Limits Guidance*).

It is acknowledged that the relative biological effectiveness (RBE) of tritium is a subject of considerable continuing debate in the scientific literature. As part of the evaluation of uncertainty for the purposes of the ERA, in accordance with section 7.3.5.8 of CSA N288.6-12, it is acknowledged that an RBE of between 1 - 3 may be applied for calculating effective dose due to tritium.

The specific RBE value for tritium beta particles used as a factor for the dose coefficients recommended by N288.1-14 is not clearly discussed in the available literature. As such, there may be uncertainty in the true effective doses, dependent on the true RBE of tritium beta particles.

Notwithstanding, even if the doses calculated for the ERA were conservatively tripled (i.e. assume the dose conversion factors originally used an RBE = 1, while uncertainty may introduce an RBE = 3), the values derived would remain far below established thresholds of acceptable risk for members of the public.

Overall, the conservatism applied in the characteristics of the critical receptors helps to bound the uncertainties associated with the risk assessment. It is highly unlikely that the uncertainties are of such magnitude that they would alter the conclusions of the overall assessment of risk to human health.

4. Ecological Risk Assessment

4.1 Problem Formulation

4.1.1 Valued Ecosystem Component Selection

The flora and fauna communities that inhabit the area around the facility are relatively diverse, despite the presence of a significant amount of urban and suburban development.

It is not practical to assess the risk and impact of SRBT operations on all plant and animal species within these communities. As a standard ERA, a select group of organisms are chosen as broadly representative of the variety of life in the area.

When choosing which organisms to select, careful consideration was made to ensure appropriate representation of all categories of organisms in the area.

For a specific representative organism to be selected as a VEC, there must be relative certainty that it exists within the area of the assessment. The selected VECs must also represent all major taxonomic groups along all significant pathways to exposure.

In addition, organisms that hold special importance or value to the area and/or Indigenous communities, or are understood to be endangered or otherwise at risk, are also selected where feasible. The representative organisms chosen through this process are known as valued ecosystem components (VECs).

The VECs that have been selected for this EcoRA are intended to represent the major plant and animal groups that have some potential to be impacted by SRBT operations, and are expected to be subject to any identified ecological exposure pathways.

The list of candidate VECs was compiled by first completing a review of available public data on the types of organisms known to exist within the area of interest.

General data were accessed using several public and governmental resources, in direct consultation with the Ministry of Natural Resources & Forestry [26]. At the recommendation of the ministry, the databases accessed for detailed information included:

- Maps and sighting data from ebird.org, for four reporting sites within the area of assessment (Riverside Park, Kiwanis Walkway, Pembroke Marina, Pembroke Memorial Centre).

- Maps and sighting data from iNaturalist.org, using a bounding map box conservatively representing the area of interest.
- Natural Heritage Area Maps and data from the Ontario Ministry of Natural Resources and Forestry – Land Information Ontario database, using the geographic information system application at gisapplication.lrc.gov.on.ca.

The general data obtained through these processes were then assessed to identify a selection of candidate species to carry forward through to screening, in line with the rationale provided above.

SRBT also researched species that may hold Indigenous importance, and collaborated with the AOPFN in order to understand those species that may be of special value or interest to their culture and heritage [27].

Based on the wide range of collaborative information gathered, the set of VECs to be included in the EcoRA was finalized, as itemized in Table 12.

VEC CATEGORY	REPRESENTATIVE SPECIES	RATIONALE
Fish	Lake Sturgeon	Suspected presence; Indigenous importance; listed as Species at Risk in other areas of province
Aquatic plant	Bulrushes	Known presence
Aquatic invertebrate	Benthic invertebrates	Taken as a general category for ecological risk assessment
Amphibian / reptile	Blanding's Turtle	Suspected presence; listed as Species at Risk
Terrestrial invertebrate	Earthworms	Known presence; link with other species, important component of food chains
Riparian bird	Ring-billed Gull	Known presence
Terrestrial bird	Barn Swallow	Known presence; listed as Species at Risk
Riparian mammal	Muskrat	Known presence
Terrestrial mammal	Red Squirrel	Known presence
Terrestrial plant	Butternut Tree	Known presence; Indigenous importance; listed as Species at Risk

TABLE 12: VEC SELECTION

Should adequate protection and limitation of risk be demonstrated for these VECs, the implication is that any other species in the same ecological category are also protected.

VEC characteristics are profiled in Appendix C, with a description of the habitat and feeding habits of the species. Assessment locations are also described based on the habitat features of the surrounding area of interest near the facility.

4.1.2 Assessment and Measurement Endpoints

The key attributes of the receptors to be protected as part of a facility's Environmental Management System and protection programs are known as the assessment endpoints. An ERA evaluates whether or not these protection goals are being (or are likely to be) achieved in relation to the assessment endpoint.

For SRBT, the key environmental goal is to minimize the impact of facility operations on all aspects of the environment. Specifically, in context of the ERA, it is important to assess the potential for facility operations to result in substantive changes to the function of the ecosystems in the area affected by the facility.

As such, an assessment of the risks to population abundance for the identified valuable ecosystem components is an appropriate way to define if ecosystem function is impacted. The risk to population abundance can be inferred by assessing the magnitude of impact at the individual level (i.e. the dose / exposure to a given hypothetical individual organism. If the risk to the individual is demonstrated to be very low, it can be concluded with a high degree of confidence that the species populations and associated ecosystems are also adequately protected.

Any macro-effects on individuals (i.e. impact on survival, reproduction, viability, etc.) can be easily derived by assessment of the COPC concentration and/or dose magnitudes, and a comparison to known benchmark doses associated with effects. These types of measurement endpoints are used to determine if it is likely that protection goals will be met under routine operations.

4.1.3 Selection of Stressors

The SRBT facility has been in operation for over three decades, with few changes to the types of key processes that take place which may present a risk to the environment. Generally, the methods implemented when SRBT manufactures tritium light sources has remained consistent since 1990.

This is not to say that there have not been changes and improvements in the magnitude of stressors that have been released over these years – in fact, SRBT has continuously made efforts to reduce environmental-related impacts of the facility, especially with respect to the release of tritium through effluent pathways.

In order to select the associated stressors that are carried forward into the ecological component of this assessment, a facility-wide review of all manufacturing processes was completed, combined with a desktop review of information pertaining to these processes through the years.

Based on this review, a comprehensive list of all potential radiological, chemical, and physical stressors that may influence ecological health risk by the facility is included in Appendices A and B. This table includes selected screening criteria, and notes describing any details on the nature of the COPC, the screening criteria and the data used for the comparison.

There are several chemical stressors that are listed that are representative components of products that are used for certain processes, or are known to be a potential fugitive emission from the process.

For example, the chemicals listed as part of potential stressors associated with silk screening activities are originally derived from published Safety Data Sheets for those products. As another example, the list of chemicals that are associated with plastic injection molding are the potential volatile species that arise with this process.

This results in a significantly more populated list of chemical species being screened than would be expected if one were only assessing those chemical products that are used routinely at the facility.

In order to select the key stressors and contaminants of potential concern (COPC) to carry forward through to the higher levels of the HHRA, the following rationale was applied.

The two significant forms of tritium (oxide, molecular) will be automatically carried forward through to the screening-level assessment, as they are understood to be relevant and significant given the nature of the operations.

For physical stressors, a general assessment will be made with appropriate measurements (where feasible) in order to determine a rational level of further assessment if warranted. Where relevant information on the ecological effects of physical stressors is available it will be used to inform the screening.

For conventional / chemical COPC, release rates and quantities will be derived either through usage data or occupational concentration measurements, and ventilation / effluent flow rates.

Where available, data from past assessments may be cited, contingent on the processes having remained relatively unchanged and/or reduced in volume since the assessment was completed.

Silk screening activities are an example where previous assessments are on file for a period when this activity was performed at a much greater rate than as of today, with the advent of the use of ultraviolet printing technologies for aircraft signs. Screening against the historical assessment is assuredly conservative, as the true risks would be much lower.

Comparisons to any known ecological toxicity data and/or limits will be made, with any COPC exceeding 20% of any limit carried forward unless otherwise justified.

Typically, point-of-release concentrations or values will be derived to characterize expected COPC introduction into the environment. In turn, ecological screening criteria may either be point-of-release or point-of-impingement concentrations / values, depending on the available guidelines or literature for the specific chemical species in question.

In applicable cases, if the point-of-release exposure level is at or below the limiting point-of-impingement screening value, protection of ecological components is logically assured and no further assessment is warranted.

Where possible, established limits from the Government of Ontario have been applied. Absent this, Federal limits and guidance will be sought. Should there be a lack of published national or provincial government guidelines, research into limits used by other jurisdictions and/or international environmental health organizations will be undertaken to determine a reasonably conservative screening criterion.

For injection molding processes specifically, ecological screening criteria for listed, measured chemical compounds have not been derived individually. Instead, the potential risks associated with this group of COPC are initially

screened on the basis of the two specific substances identified as most limiting in the HHRA – acetonitrile and vinyl acetate. If either of these contaminants exceed ecological screening criteria, a more detailed assessment of other potential COPC from this process may be warranted.

The selection process described above has been applied to identify COPC and physical stressors that will be carried forward through to a more detailed assessment of ecological risks.

The process concluded that from the point of view of physical or non-radiological stressors, there are no COPC that are reasonably expected to have any impact on ecological receptors in the area surrounding the SRBT facility, with the sole exception of noise as a physical stressor.

In summary, the only COPC carried forth for a more detailed assessment are the various forms of tritium (oxide, molecular/elemental gas), along with noise.

4.1.4 Selection of Exposure Pathways

There are two sources of COPC releases originating from the facility – gaseous emissions from the active ventilation systems, and COPC-bearing liquid at the outfall from the Pembroke Pollution Control Centre (PPCC).

Contaminant dispersion from source to receptor, and the characteristics of this transport, constitute the exposure pathways. This includes transport through the food chain where applicable.

Where available, direct measurements of COPC concentrations have been used to inform the risk assessment; where not available, best estimations have been made based upon the understanding of dispersion mechanisms.

Exposure pathways selected include:

- Ingestion of water, soil and food containing COPC;
- Inhalation of air containing COPC;
- External contact with water containing COPC, and subsequent bioaccumulation;
- External contact with soil containing COPC from soil, and subsequent bioaccumulation;

Depending on the specific VEC, the dominant exposure pathway will vary. For fish and other aquatic biota, exposure will be dominated by uptake of water containing COPC, while for mammals, the ingestion of food is expected to dominate.

Exposure to noise assumes a pathway of effect at the boundary of the area controlled by the facility, where wildlife may be located.

4.1.5 Ecological Conceptual Models

Conceptual exposure models have been created to illustrate how the selected VECs are likely to be exposed to COPC in both the aquatic and terrestrial environments. Source and receptor relationships are identified, thus describing the key exposure pathways for each selected species.

The models for each of the selected ecological receptors are presented below in Table 13. The models are also graphically illustrated for clarity and accurate representation in Figures 16 and 17.

VEC CATEGORY	SPECIES SELECTED	EXPOSURE PATHWAY	MEDIA
Fish	Lake Sturgeon	Ingestion	Water, benthic invertebrates
		Absorption	Water
Aquatic plant	Bulrushes	Osmosis	Water
Aquatic invertebrate	Benthic invertebrates	Ingestion	Water, sediment
		Absorption	Water
Amphibian / reptile	Blanding's Turtle	Ingestion	Water, benthic invertebrates
		Inhalation	Air
Terrestrial invertebrate	Earthworms	Ingestion	Water
		Inhalation	Air

TABLE 13: EcoRA CONCEPTUAL MODEL PATHWAYS

VEC CATEGORY	SPECIES SELECTED	EXPOSURE PATHWAY	MEDIA
Riparian bird	Ring-billed Gull	Ingestion	Water, benthic invertebrates, red squirrel (as a representative rodent), Earthworm, Lake Sturgeon, Bulrushes
		Inhalation	Air
Terrestrial bird	Barn Swallow	Ingestion	Water, benthic invertebrates (as a representative of aerial insects that make up typical species diet)
		Inhalation	Air
Riparian mammal	Muskrat	Ingestion	Water, benthic invertebrates, bulrushes, some limited fish (Lake Sturgeon used as representative)
		Inhalation	Air
Terrestrial mammal	Red Squirrel	Ingestion	Water, tree bark, nuts and seeds (Butternut used as representative), limited insects (benthic invertebrates used as representative)
		Inhalation	Air
Terrestrial plant	Butternut Tree	Osmosis	Water

TABLE 13: EcoRA CONCEPTUAL MODEL PATHWAYS (cont'd)

Graphical representations of the conceptual ecological models (terrestrial and aquatic) are provided on the following page as Figures 16 and 17, respectively.

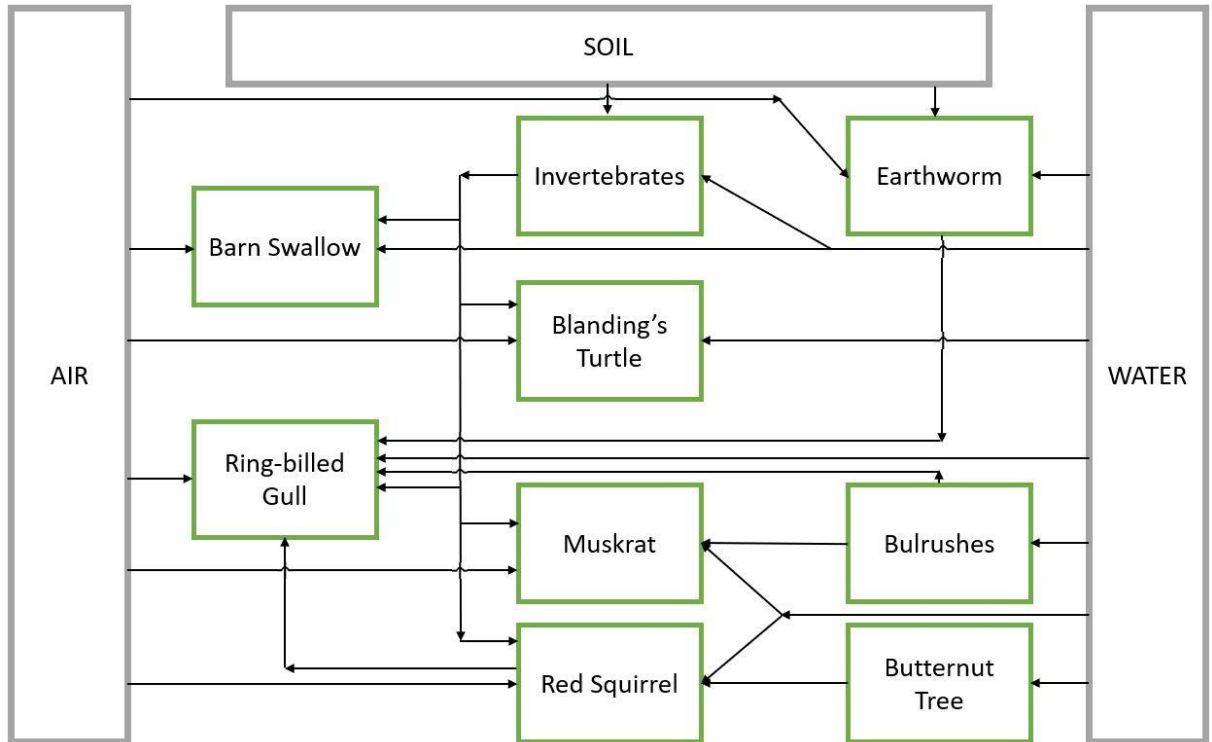

FIGURE 16: TERRESTRIAL CONCEPTUAL ECOLOGICAL MODEL

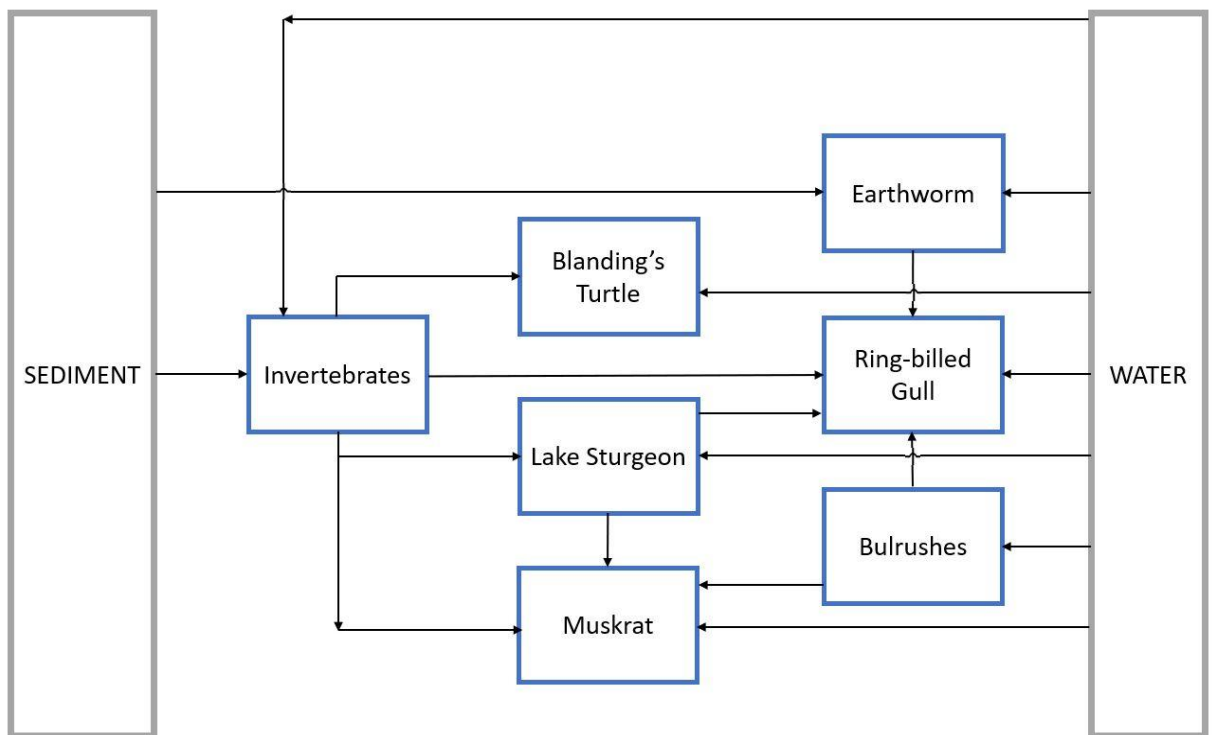

FIGURE 17: AQUATIC/RIPARIAN CONCEPTUAL ECOLOGICAL MODEL

(air inhalation not depicted for muskrat, turtle, gull or earthworm but is accounted for in exposure assessment)

4.1.6 Uncertainty in Problem Formulation

Although there is confidence that selected species representing the VECs included in this EcoRA exist near the facility, there has not been a detailed environmental survey of the population sizes or abundance of these species.

The ecological pathway modelling between the selected VECs is based upon best available literature and descriptions of the characteristics of each species.

Assumptions on intake fractions of omnivorous animals are made, which would introduce uncertainty as well.

Overall, the uncertainties in the EcoRA problem formulation are not expected to result in any underestimation in the calculation of exposure rates or doses, primarily as a result of the various conservatisms applied in the exposure assessment.

It is also unlikely that there are unconsidered species present in the area that are expected to be subject to significantly greater risk than the representative VECs.

4.2 Exposure Assessment

For tritium, a quantitative assessment has been implemented in order to derive VEC-specific dose rates, and contrast these against the selected benchmark.

Each of the individual factors that impact the tritium-related radiological dose rate calculation for each of the selected VECs is discussed in detail in the following sections.

The complete set of dose rate calculations for the EcoRA are tabulated in Appendix E.

4.2.1 Exposure Points

The SRBT EMP has gathered extensive data over the course of three decades of facility operations, allowing for either direct use of measured concentrations of tritium at the point of hypothesized impingement, or a derivation of concentrations by means of reasonably conservative calculations of the behaviour of tritium in the environment.

Note that the key factors underlying the EcoRA are reflective of chronic exposure. Appendix D summarizes the exposure locations and assessed tritium concentrations for all VECs selected as part of the EcoRA.

4.2.2 Conservative Treatment of Exposure Data

In line with the treatment of data used for the HHRA, the data applied for the purposes of the EcoRA will be set using a similar methodology.

The methodology is as follows:

- For each of the exposure inputs described by the conceptual model, select the highest validated EMP measurement of the contaminant concentration from the last eleven years of operations (2015-2025 calendar years), at the point of exposure.
- Multiply this value by a factor of 2 in order to add additional conservatism, and account for potential increases or variation in facility production rates. Round up any values to the nearest unit.
- Where direct measurement of tritium concentration is not available, either calculate a value indirectly using dispersion or partitioning models, or select a representative value that is defensibly conservative.
- Apply reasonable intake or occupancy rates and biota-specific exposure factors for air, water and food as applicable, in line with guidance provided by CSA Standard N288.6-12 and N288.1-14 (or other applicable guidance).
- Derive individual pathway doses for each VEC.
- Add doses for all pathways together for a total calculated potential exposure dose or dose rate to a given VEC.

4.2.3 Exposure and Dose Calculations

Tritium dose rate calculations consider several specific factors and inputs for each individual VEC.

Details on the derivation and/or selection of key calculation parameters are provided below.

The complete tabular summary of the exposure calculations for each VEC is provided in Appendix E.

4.2.3.1 Dose Coefficients

For tritium, the weighted internal absorbed dose rate per activity concentration in all VECs (otherwise known as an internal dose coefficient) is taken as $3.3\text{E-}06$ $\mu\text{Gy/h}$ per Bq/kg (fresh weight).

In the aquatic environment, for pelagic and benthic organisms, the external absorbed dose rate per activity concentration is $7.8\text{E-}12$ $\mu\text{Gy/h}$ per Bq/kg (fresh weight). For aquatic invertebrates, the external absorbed dose rate is $1.0\text{E-}11$ $\mu\text{Gy/h}$ per Bq/kg (fresh weight). For aquatic plants, the external absorbed dose rate is $8.2\text{E-}12$ $\mu\text{Gy/h}$ per Bq/kg (fresh weight). External dose rates for terrestrial biota are taken to be zero.

These values are all obtained from UNSCEAR 2008 Report: Volume II, Annex E, Tables 14 and 15.

As the external absorbed dose coefficient for organisms is several orders of magnitude lower than the internal coefficient for tritium, for the purposes of the assessment this dose component is considered insignificant and is excluded from the calculation of dose rates.

The resultant radiological dose rate (in $\mu\text{Gy/h}$) for any given VEC is calculated by multiplying the internal dose coefficient (DC) by the concentration of tritium in the tissue of the organism (C_t).

$$\text{Dose rate} = \text{DC} \times C_t$$

A final consideration specific for tritium as a COPC is an accounting of the effect of organically-bound tritium in biota.

Various references (e.g. UNSCEAR 2008) do not provide a DC explicitly for OBT. There are some different options for resolving this, depending on the availability of data on OBT concentration in biota.

The OBT DCF for humans is between 2.3 - 2.5 times higher than the HTO DCF (see Table C.2 of N288.1-14). A similar factor could be applied to the ecological internal DC value for HTO (previously cited as $3.3\text{E-}06$ $\mu\text{Gy/hr}$ per Bq/kg fresh weight).

Using a factor of 2.5 times higher, the ecological DC for OBT becomes $8.25\text{E-}06$ $\mu\text{Gy/hr}$ per Bq/kg fresh weight. This value could be applied equally to all biota where OBT concentrations are known or estimated.

In the absence of measured OBT data on the selected VECs, an OBT:HTO tissue concentration ratio of 0.1 could be applied (based on best available ratio data) in order to derive estimated OBT concentrations.

Combining the OBT DC (2.5 times greater than HTO DC) with the OBT:HTO tissue concentration ratio (0.1) leads to a single combined factor of 1.25 that could be applied to the calculated HTO dose for each VEC.

There is precedent for this type of treatment of OBT in an EcoRA – the 2017 Bruce Power ERA applied an adjustment factor of 1.5 to the HTO dose rate to account for OBT in a conservative fashion [28].

The approach outlined above has been applied for the purpose of this ERA, and the calculated dose rate for HTO has been multiplied by a factor of 1.5 to conservatively account for the effect of OBT in VECs.

This final calculated dose rate is then contrasted with the selected benchmark to ascertain the risk associated with routine tritium releases during SRBT operations.

4.2.3.2 Tissue Concentrations

As recommended by CSA N288.6-12, clause 7.3.4.3.6, the uptake of tritium by plants and animals has been calculated using specific activity models. These models are based on the concept of isotopic exchange between tissues and ambient media.

N288.6-12 describes the calculations used to determine tissue concentrations in different types of organisms.

The tissue concentrations (C_t) for plants, invertebrates and fish are calculated using bioaccumulation factors (BAFs), as per section 7.3.4.3.1 of N288.6-12, as follows:

$$C_t = C_m \cdot \text{BAF}$$

where,

- C_t = whole body tissue concentration (Bq/kg fresh weight)
- C_m = media concentration (Bq/L or Bq/kg)
- BAF = bioaccumulation factor (L/kg or kg/kg)

See section 4.2.3.5 for a discussion on bioaccumulation factors used in the calculation of tissue concentrations in VECs.

For birds and mammals, tissue concentrations from food intake are derived using transfer factors (TFs) and the concentrations in their food and water, as follows:

$$C_t = \sum C_x \cdot \text{TF} \cdot \text{IF}$$

where,

- C_x = concentration in the ingested item (Bq/kg fresh weight)
- TF = ingestion transfer factor
- IF = intake fraction of item in diet

See section 4.3.4.6 for a discussion on transfer factors used in the calculation of tissue concentrations in VECs.

The sole plant where this process was not followed was bulrushes – instead, values obtained from the sampling and analysis of riparian and aquatic plants since 2021 was used for tissue concentration of that species.

4.2.3.3 Body Weights

Organism body weight does not factor into the calculation of tritium-related radiological dose rate to selected VECs, as the calculations are based on specific-activity modeling.

As there are no other radionuclides or non-radiological COPC being considered quantitatively as part of this ERA, organism body weights need not be tabulated for the VECs.

4.2.3.4 Intake Fractions

For two of the selected VECs with intakes of multiple types of food (i.e. muskrat and ring-billed gull), fractions of intake are applied for each food type.

For the muskrat, it is assumed that 95% of their diet comes from plant matter (i.e. represented by bulrush plants for the purposes of this assessment), with the remainder comprised of benthic invertebrates.

For the ring-billed gull, the five types of food considered (earthworm, bulrushes, benthic invertebrates, fish and small mammal) are each assumed to comprise of an equal proportion of the total diet (20% each).

4.2.3.5 Bioaccumulation Factors

As noted above, tissue concentrations may be derived as a product of the concentration of tritium in the ingested media, and a bioaccumulation factor.

For aquatic animals and plants, it is assumed that the activity of tritium in the tissue water of the plant / animal is in equilibrium with the tritium concentration of the water in which the organism exists.

As such, in accordance with section 7.7.4.1 of CSA N288.1-14, the bioaccumulation factor can be expressed as the fraction of the water content of the aquatic organism:

$$BAF_{HTO} = 1-DW$$

...where 'DW' (dry/fresh weight ratio) is the non-water content of the animal or plant (i.e. 1-DW is equal to the water content of the animal or plant, expressed in litres of water per kilogram fresh weight).

In the case of this assessment, a global fraction of 75% has been applied – giving a bioaccumulation factor of 0.75 L per kg fresh weight, for all aquatic VECs. Although the water content value of aquatic animals and plants varies, an assumed 75% water content is a reasonable approximation for the purposes of the assessment, and is consistent with the guidance outlined in section 7.7.4.2 of CSA N288.1-14.

For terrestrial plants, as per OPG 2017 [29], a bioaccumulation factor for the soil to plant pathway can be expressed as a ratio of the transfer of tritium from the air to the plant, and the transfer of tritium from the air to the soil pore water.

This factor can be derived using data taken from CSA N288.1-14, and applying the following calculation:

$$BAF_{HTO} = (P_{air_plant} \times A) / (P_{air_soilwater} \times B \times 1000)$$

Where,

- P_{air_plant} = transfer from the air to the plant (m^3/kg fresh weight)
- A = bulk density of the soil (kg/m^3)
- $P_{air_soilwater}$ = transfer from air to soil pore water (m^3/L)
- B = volumetric moisture content of the soil (m^3 water / m^3 soil)
- BAF_{HTO} = bioaccumulation factor for soil to plant (kg dry weight/ kg fresh weight)

Table A.5 of CSA N288.1-14 has a selection of site-specific values for the transfer of tritium from air to plant ($P_{\text{air_plant}}$). In all cases, for 'forage' plants, the value given is 49.5 m³/kg fresh weight. This value is taken as equally applicable to the SRBT site for the purposes of this ERA.

Table A.4g of CSA N288.1-14 lists 60 m³/L as the Eastern Ontario regional default value for the transfer of tritium from air to soil pore water ($P_{\text{air_soilwater}}$).

As noted in section 2.6 of this report, the overburden in the area near the facility is predominantly comprised of clay-like soils. CSA N288.1-14, section 6.3.2.2 notes a bulk density value of 1400 kg/m³ for clay (A), and section 6.3.4.3 notes a volumetric moisture content of 0.3 for clay soil (B).

Given these figures, for the purposes of this assessment the bioaccumulation factor for terrestrial plants is thus calculated as 3.85 Bq/kg fresh weight per Bq/kg in soil.

For terrestrial invertebrates, a value of 1.5E+02 Bq/kg fresh weight per Bq/kg in soil has been cited in the literature [29] as a reasonable equilibrium concentration ratio, and this value has been used as the bioaccumulation factor in other assessments [30]. It has been adopted for the purpose of this ERA.

The bioaccumulation factors applied in this ERA are presented below in Table 14.

VEC TYPE	UNITS	TRITIUM BAF	REFERENCE
Aquatic	Bq/kg fw per Bq/L	0.75	See text, CSA
Terrestrial Plants	Bq/kg fw per Bq/kg in soil	3.85	See text, OPG 2017, CSA
Terrestrial Invertebrates	Bq/kg fw per Bq/kg in soil	150	Beresford, 2008

TABLE 14: BIOACCUMULATION FACTORS

4.2.3.6 Transfer Factors

For vertebrates (birds, mammals, reptiles), tritium intake from ingestion of water and food constitutes the most significant exposure pathway. Exposure calculations thus hinge on calculating the tissue concentrations in the plants and animals that they consume, as well as concentrations in drinking water and air.

The tritium intake by water ingestion is calculated in accordance with equations given in section 6.9.2.1 of CSA N288.1-14, as follows:

$$P_{\text{HTOwater_animal}} = k_{\text{aw}} \times f_{\text{w_w}} \times (1 - DW_{\text{a}})$$

where,

- k_{aw} = fraction of water ingested from a particular contaminated source (in the case of the ERA, this is assumed to be 100%, or a fractional value of 1);
- $f_{\text{w_w}}$ = fraction of a given animals water intake that comes from direct ingestion of water. CSA N288.1-14 suggests a range of between 0.3 – 0.5 for this factor; a reasonable value of 0.5 for wild animals may be applied;
- DW_{a} = dry/fresh weight ratio for animal products (kg dry weight per kg fresh weight). CSA N288.1-14 suggests a reasonable value of 0.3 may be applied.

Calculating this through gives a tritium transfer factor equal to 0.35 L per kg fresh weight for the water ingestion pathway for animal VECs considered in this ERA.

For tritium intake from plant ingestion, the calculation cited for ingestion of plants in section 6.10.2.1 of CSA N288.1-14 is applied as follows:

$$P_{\text{HTOfood_animal}} = k_{\text{af}} \times ((1 - f_{\text{OBT}}) \times f_{\text{w_pw}} + 0.5 \times f_{\text{w_dw}}) \times (1 - DW_{\text{a}})/(1 - DW_{\text{p}})$$

where,

- k_{af} = fraction of feed from contaminated sources (in the case of the ERA, this is assumed to be 100%, or a fractional value of 1);
- f_{OBT} = fraction of total tritium in the animal product in the form of OBT as a result of HTO ingestion (CSA N288.1-14 suggests a reasonably conservative value of 0.15 for wild animals may be applied (from value used for pork in Table 17), and has been used in other assessments);

- f_{w_pw} = fraction of the animal water intake derived from water in the plant feed (CSA N288.1-14 suggests a reasonably conservative value of 0.65 for wild animals may be applied (from value used for wild waterfowl in Table 16), and has been used in other assessments);
- f_{w_dw} = fraction of the animal water intake that results from the metabolic decomposition of the organic matter in the feed (CSA N288.1-14 suggests a reasonably conservative value of 0.121 for wild animals may be applied from value used for wild waterfowl in Table 16), and has been used in other assessments);
- DW_a = dry/fresh weight ratio for animal products (kg dry weight per kg fresh weight). CSA N288.1-14 suggests a reasonable value of 0.3 may be applied.
- DW_p = dry/fresh weight ration for plant products (kg dry weight per kg fresh weight). CSA N288.1-14 suggests a reasonable value of 0.2 may be applied (as per Table G.5).

Calculating this through gives a unitless transfer factor of 0.54 for tritium intake from plant ingestion by animals considered in this ERA.

This factor will be applied for the ingestion of food items as well, as there are few instances of ingestion of animal foods in the site-specific ecological models, and as there are no equivalent animal-specific factors provided for some of the terms in the equation in N288.1-14.

For transfer of tritium from air inhalation, as per section 6.12.2.1 of N288.1-14, the model is the same as for drinking water to animals in that a specific amount of moisture in the air is taken up by the organism in accordance with the following calculation:

$$P_{HTOair_animal} = [f_{w_sw} \times (1 - DW_a)] / H_a$$

where,

- f_{w_sw} = fraction of water intake derived from inhalation and skin absorption (Table 16 of CSA N288.1-14 suggests a range of fractions for various animals; 0.01 is selected as a reasonable value)
- DW_a = dry/fresh weight ratio for animal products (kg dry weight per kg fresh weight). CSA N288.1-14 suggests a reasonable value of 0.3 may be applied.
- H_a = atmospheric absolute humidity (L/m^3) (Table 11 of CSA N288.1-14 notes an acceptable annual average of 0.005 for Eastern Ontario)

Calculating this through gives a transfer factor of 1.40 m³ per kg fresh weight for tritium intake through inhalation by animals.

The transfer factors applied in the EcoRA are presented below in Table 15.

VEC TYPE	WATER INGESTION TRANSFER FACTOR (L/kg fresh weight)	FOOD INGESTION TRANSFER FACTOR (unitless)	AIR INHALATION TRANSFER FACTOR (m³/kg fresh weight)
Animals	0.35	0.54	1.40

TABLE 15: TRITIUM TRANSFER FACTORS

4.2.4 Uncertainties in Exposure Assessment

Several uncertainties are acknowledged in the data and assumptions that influence the exposure assessment for the EcoRA.

There is a significant amount of data from the EMP that were utilized to quantify the concentration of tritium in air, soil and water throughout the local environment.

Measurements taken as part of the EMP represent conditions at a particular location at a given time, and there would be variations in concentrations over both time and space. It is uncertain if any given EMP result would represent the specific conditions encountered by VECs over their life history at the various locations where they might reside.

This source of uncertainty has been addressed by consistently incorporating considerably conservative assumptions in the selection of the representative concentrations of COPC in the various media in the environment.

For example:

- In several cases, double the maximum measured concentration in environmental media over the past eleven years was used for the assessment;
- Values that were measured close to the facility were used as assumed concentrations further away.
- In the initial screening assessment, the comparative screening criteria for many COPC were set at one-fifth of published regulatory 'no-effect' limits.

The concentrations of tritium applied to VECs and inputs within the Muskrat River riparian / benthic / pelagic zones has begun to be characterized since the first ERA was accepted. This has eliminated some uncertainty in the exposure assessment.

The characteristics of each of the selected species of VECs are based on generic representations of the broader VEC categories, and the specific attributes of each species have not been considered.

To account for any associated uncertainty, the representative attributes (e.g. bioaccumulation and transfer factors, and dietary intake fractions) have been based on relatively conservative recommendations taken from relevant standards and guidance.

Although there are a few sources of uncertainty in the exposure assessments performed, with the various conservatisms introduced (e.g. doubling of the highest eleven-year EMP measurements in many cases), there is little likelihood that the overall conclusions of the EcoRA will change, especially considering that the resulting dose rate for the most-exposed organism is only ~2.7% of the selected benchmark dose rate.

Overall, the identified uncertainties are not expected to result in any significant level of underestimation of dose or risk, or to translate to uncertainty in the ERA conclusions.

4.3 Effects Assessment and Risk Characterization

4.3.1 Radiological Risk Characterization

By convention, the quantification of risk is achieved through comparison of estimated dose with an established benchmark dose.

A benchmark dose rate of 100 $\mu\text{Gy/h}$ has been selected in order to conservatively characterize the population risks associated with the exposure of the selected VECs to the sole COPC that was not screened out (tritium).

This benchmark value is taken from UNSCEAR (2008) as the threshold for population-significant effects in terrestrial organisms.

A value of 400 $\mu\text{Gy/h}$ is recommended for aquatic biota by UNSCEAR (2008), but for the purposes of this ERA, a global benchmark of 100 $\mu\text{Gy/h}$ will be conservatively applied for all species, as recommended in CSA N288.6-12.

As well, for the individual organism, a benchmark value of 1 mGy/d will be applied across all selected species, in line with CSA N288.6-12, clause 7.2.4.3, and IAEA Technical Report Series No. 332 (1992).

Table 16 provides a summary of the conservatively calculated dose rates for each individual VEC type, along with a percentage that the calculated dose rate represents when compared to the selected benchmark dose rates.

In all cases, the risks to VECs are acceptably low, considering the very conservative assumptions made with respect to the tritium concentrations that each organism is likely to be exposed to.

The highest dose rate calculated is that of a terrestrial earthworm (i.e. one that inhabits an area near very close to the facility), with a calculated dose rate of 2.733 $\mu\text{Gy/h}$, a value that is just short of 3% of the population benchmark dose rate of 100 $\mu\text{Gy/h}$, or just below 7% of the individual benchmark dose rate on 1 mGy/d.

VEC CATEGORY	CALCULATED DOSE RATE ($\mu\text{Gy/h}$)	% OF POPULATION BENCHMARK	% OF INDIVIDUAL BENCHMARK
Benthic invertebrates	4.90E-04	0.000%	0.001%
Bulrushes	3.19E-02	0.032%	0.077%
Butternut	6.18E-02	0.062%	0.148%
Earthworms – Riparian	1.46E+00	1.462%	3.509%
Earthworms – Terrestrial	2.73E+00	2.733%	6.559%
Lake Sturgeon	3.69E-04	0.000%	0.001%
Blanding’s Turtle – Riparian	3.47E-03	0.003%	0.008%
Blanding’s Turtle – Terrestrial	6.22E-03	0.006%	0.015%
Muskrat – Riparian	1.96E-02	0.020%	0.047%
Muskrat – Terrestrial	2.23E-02	0.022%	0.054%
Barn Swallow	6.22E-03	0.006%	0.015%
Red Squirrel	3.93E-02	0.039%	0.094%
Ring-billed Gull	3.09E-01	0.309%	0.741%

TABLE 16: CONSERVATIVELY CALCULATED DOSE RATES FOR EACH VEC

For comparison, a more realistic assessment of the calculated dose rates for each VEC is presented below in Table 17. These dose rates are derived using eleven-year average concentrations for the relevant environmental pathways, rather than single maximum values (see Appendix D).

For soil, average EMP values were not available as this material is not sampled routinely; as such, less conservatively characterized soil concentrations (219 Bq/kg for terrestrial, and 50 Bq/kg for riparian and aquatic habitats) were assigned based on previous measurements and judgement.

VEC CATEGORY	CALCULATED DOSE RATE ($\mu\text{Gy/h}$)	% OF POPULATION BENCHMARK	% OF INDIVIDUAL BENCHMARK
Benthic invertebrates	1.00E-04	0.000%	0.000%
Bulrushes	1.26E-03	0.001%	0.003%
Butternut	1.56E-03	0.002%	0.004%
Earthworms – Riparian	9.36E-02	0.094%	0.225%
Earthworms – Terrestrial	9.80E-02	0.098%	0.235%
Lake Sturgeon	7.47E-05	0.000%	0.000%
Blanding’s Turtle – Riparian	2.05E-04	0.000%	0.000%
Blanding’s Turtle – Terrestrial	2.15E-04	0.000%	0.001%
Muskrat – Riparian	7.97E-04	0.001%	0.002%
Muskrat – Terrestrial	8.07E-04	0.001%	0.002%
Barn Swallow	2.15E-04	0.000%	0.001%
Red Squirrel	1.00E-03	0.001%	0.002%
Ring-billed Gull	1.10E-02	0.011%	0.026%

TABLE 17: REALISTICALLY CALCULATED DOSE RATES FOR EACH VEC

Based on this assessment of the impact of tritium in the environment surrounding SRBT, and coupled with the fact that no other radiological COPC are released in concentrations or amounts that exceed reasonable screening criteria, it can be said with a high degree of confidence that the cumulative radiological risk to individual organisms and populations of organisms in the area of interest is acceptably low, and no effects are expected at any trophic level.

4.3.2 Non-radiological Risk Characterization

All non-radiological chemical stressors that are potentially associated with SRBT facility operations were assessed as part of the screening process.

In each case, it was shown that the conservatively estimated levels of exposure to these substances at the point of release were lower than the conservatively selected screening criterion, which are considered to be no-effect concentrations.

Accordingly, no measurable adverse effects are expected due to exposure to non-radiological COPC, and the risk is acceptably low.

4.3.3 Physical Risk Characterization

With respect to noise levels, refer to Table 13 for data on the measured levels of noise at the perimeter of the facility during routine operations.

The highest recorded noise level that can be confidently attributed to the SRBT facility at the perimeter of the area of control (56 dB) is of similar magnitude to normal human conversation (around 60 dB) [31].

There are no specific noise level thresholds for ecological receptors defined within regulatory documents.

The measured noise levels are deemed to be well within reasonably acceptable noise levels commonly associated with a semi-urban / business park environment.

Given that other nearby sources of noise are key contributors to ambient noise levels near the facility (i.e. traffic on Boundary Road, other nearby facilities), the noise emanating from the SRBT facility is very unlikely to pose a direct, adverse effect on any nearby ecological receptors.

All other physical stressors that are potentially associated with the facility were assessed as part of the screening process, and determined to be well below levels at which there might be any significant impact to ecological health. This includes artificial night lighting, vehicular traffic, and other potential stressors.

In summary, based on this assessment the risks to VECs from physical stressors are deemed to be extremely low, and well within acceptable levels.

4.3.4 Cumulative Risk Characterization

Based on the results of the above assessments of risk potentially associated with various categories of stressors, it can be stated with a high degree of confidence that the cumulative risks to VECs, and by extension all organisms in the environment, posed by the routine operations of the SRBT facility are acceptably low, and are expected to remain acceptably low for the foreseeable future.

This includes risks associated with all radiological, non-radiological and physical contaminants and stressors.

4.3.5 Uncertainty in Risk Characterization

Although there are uncertainties both in the selection and characterization of the VECs, and in the calculation of exposure and dose rates experienced, a considerable level of conservatism was applied at each step in order to add confidence in any conclusions on the level of risk presented by the routine operation of the SRBT facility.

As such, although there are uncertainties in the magnitude of the risk to any given organism in the surrounding area, it is expected that the actual risk is much lower than that identified in this EcoRA.

The comparison of the conservatively-calculated dose rates against the dose rates associated with the more realistic scenarios demonstrates that the uncertainties are not likely to alter the overall conclusions of the ERA.

5. Conclusions and Recommendations

5.1 Conclusions

As noted in Section 1 of this report, the main objectives of the SRBT ERA are:

- To describe and assess the potential risks to both human and non-human receptors, as a result of current operations of the nuclear substance processing facility,
- To assess whether the scope and focus of the programs that comprise SRBT's EMS are reasonable and appropriate, and
- To determine if there is any need for further assessment or actions in order to optimize the management of environmental risk associated with facility operations.

It can be concluded that the risks to all probable receptors from all potential stressors associated with routine operations of the SRBT facility have been adequately assessed using a conservative methodology.

For the key radiological COPC assessed (tritium), by basing exposure on the highest environmental measurements in the past eleven years, and applying an additional rounded factor of two to these values, it has been demonstrated that any possible increase in processing rates and production at the facility is unlikely to introduce a level of risk that is significantly higher than concluded herein.

Given the risk assessment results, and the historical data generated as part of the monitoring programs implemented, it is concluded that the scope and focus of these programs remain reasonable and appropriate. SRBT continuously monitors the environmental impact of our facility operations through these programs.

Based on the risk assessment, there is no need for further assessment or actions in order to optimize the management of risk; however, continued application of the ALARA principle, effective implementation of our programs, and the application of best practices will continue to ensure that the risk remains negligible.

These conclusions are supported by the annual assessment of human doses each year as part of regulatory compliance reporting, which for several years have indicated that public dose has been less than 10 $\mu\text{Sv/a}$ for the most-exposed member of the public.

As well, CNSC Independent Environmental Monitoring Program data have confirmed that measured tritium in the environment is consistently below reference levels, which are based on conservative assumptions about the exposure that would result in a dose

of 0.1 mSv in a year – a value which represents one-tenth of the CNSC's public dose limit of 1 mSv per year. No health impacts are expected at this dose level.

In conclusion, the SRBT nuclear substance processing facility has operated, and continues to operate, in a fashion that is fully protective of human and ecological receptors in the surrounding area.

Although risks to receptor organisms are insignificant, they are still subject to ongoing management through the existing SRBT management system, safety programs and operating processes.

5.2 Recommendations

The ERA process is cyclical, and the assessment is required to be reviewed and updated as necessary, and as described in the governing standard. The findings of each iteration of the ERA should inform subsequent iterations, and should also be used to identify needs or opportunities to improve.

The previous iteration of the SRBT ERA recommended a suite of additional sample types that have reduced the degree of uncertainty inherent in the assessment. The introduction of a special annual sampling campaign of various media that represent VEC exposure inputs has added significant data that has been carried into this assessment, and thus reduced uncertainties.

One sample type that has not been incorporated as part of routine campaigns is other animal products and/or game fish in the area. This may not be feasible near the facility; however, sampling and analysis of these types of ecosystem components could be considered in partnership with support of members of nearby communities.

As well, in the next ERA cycle, soil sampling in the area could help to increase the certainty of exposure conditions to certain VECs, including the most exposed species, the terrestrial-based earthworm.

It is not expected that the facility operations will change significantly in the next five years; however, as part of the Management Review process, the responsible manager for the EMS should assess if the report on file continues to be valid, or if there have been operational changes that may warrant the advancement of the review and update process. This conclusion should be documented as part of that process.

The conclusions of this risk assessment are robust and defensible; however, implementation of the above recommendations would be aligned with SRBT's policy of continual improvement of both our facility operations, and of our EMS and its associated programs.

6. Quality Assurance

6.1 Quality of Assessment Data

For radiological contaminants of concern, the data utilized as part of the SRBT ERA has been generated under a quality control system that meets the requirements of both CSA N286-12, *Management systems for nuclear facilities*, and ISO 9001:2015, *Quality Management Systems - Requirements* (inclusive of previous versions).

SRBT maintains certification to the ISO 9001 standard, and our certificate is administered and verified by an independent, qualified contractor, who completes an extensive audit of our Management System annually. SRBT has maintained certification to this standard since 1997.

Much of the data pertaining to the measurement of tritium in the environment surrounding SRBT has been gathered by independent, qualified third-party contractors over the course of the past two decades. Various sampling and measurement activities have been effectively performed by both Canadian Nuclear Laboratories, and the Canadian Centre for Accelerator Mass Spectrometry and Radioisotope Research laboratory at the University of Ottawa.

All third-party EMS work and output is subject to review and audit by SRBT, and the services and data quality provided over the years has been satisfactory or better.

A relatively smaller set of the EMP data used has been gathered and generated in-house. All EffMP data are generated in-house under SRBT processes, with routine, independent third-party confirmatory sampling and analysis being built into the programs.

SRBT has been moving towards increasing the amount of sampling and analysis work performed in-house over the past decade; GMP data has been generated in-house since 2017, and certain EMP sampling and analyses have been performed by SRBT since early 2019. In all cases, at least annually an independent verification exercise is conducted with a qualified third-party laboratory to ensure high degrees of precision, accuracy, and confidence in all SRBT-generated environmental data.

All SRBT EMS processes include routine, independent verification steps in order to ensure a high level of data quality. Measurement quality controls are applied and verified at each step. Calculation and data entry verification processes are also built into SRBT's EMS program set, as well as data review and reporting functions.

6.2 Quality Assurance of ERA Report

This version of the ERA has been completed in accordance with SRBT's *Environmental Risk Assessment Process*.

This internal process ensures that the undertaking of the risk assessment, the documentation of the final report, and the implementation of recommendations are performed in a controlled manner, in compliance with the requirements of CSA standard N288.6-12, *Environmental risk assessments for Class I nuclear facilities and uranium mines and mills*.

The first version of this report was extensively reviewed by an independent third party with experience in ecological and human health risk assessment, the N288.6-12 and N288.1-14 standards, and is knowledgeable of the SRBT facility, its processes and the impacts of operations on the environment. This revision does not significantly deviate from the methodologies applied in the previous version.

SRBT Senior Management has also reviewed and approved the ERA report for submission to CNSC staff, and subsequent public release as part of our compliance with our licensing basis.

7. References

- [1] Lemire, A and Dixon, D, *Derived Release Limits for the Proposed Tritium Lamp Factory*, 1990
- [2] Canadian Nuclear Safety Commission Public Hearing Transcript, Hearing 00-H28, December 13, 2000, page 18
- [3] Canatom Inc., *A Revised DEL Calculation for the Pembroke Facility*, CRWS Report 6523-03 Rev. 1, November 19, 1996
- [4] Canadian Nuclear Safety Commission, *Canadian Environmental Assessment Act Screening Report*, November 2000 (E-Docs 3007062, pg. 6-54)
- [5] Canadian Nuclear Safety Commission Public Hearing Transcript, Hearing 00-H28, December 13, 2000, page 21-22
- [6] Grey, M, *Review of the DEL Calculation for the SRB Technologies (Canada) Inc. Facility in Pembroke, Ontario*, February 6, 2004
- [7] EcoMetrix Inc., *Derived Release Limits (DRLs) for the SRB Pembroke Facility – 2006*, January 2006
- [8] Order Under Subsection 37(2) of the Nuclear Safety and Control Act, issued by Thompson, P., dated November 16, 2005
- [9] Canadian Nuclear Safety Commission Public Hearing Transcripts, Hearing 05-H26, September 15, 2005 and November 30, 2005
- [10] EcoMetrix Inc., *Study of Tritium in Groundwater in the Vicinity of the SRB Pembroke Facility*, March 2006
- [11] EcoMetrix Inc., *Comprehensive Report – Groundwater Studies at the SRB Technologies Facility, Pembroke, ON*, January 2008
- [12] Record of Proceedings, Including Reasons for Decision, CNSC Hearing Number 06-H16, Date of Decision: January 15, 2007
- [13] Record of Proceedings, Including Reasons for Decision, CNSC Hearing Number 08-H6, Date of Release of Decision: June 26, 2008
- [14] Record of Proceedings, Including Reasons for Decision, CNSC Hearing Number 10-H5, Date of Decision: June 30, 2010

References, continued...

- [15] *Environmental Assessment Information Report: SRB Technologies (Canada) Inc. Nuclear Substance Processing Facility Operating Licence Renewal*, March 2015, (E-Doc 4578578), as included in Commission Member Document CMD 15-H5
- [16] Record of Proceedings, Including Reasons for Decision, CNSC Hearing Number 15-H5, Date of Decision: June 29, 2015
- [17] *Gap analysis – Regulatory Requirements and Standards for Environmental Management and Protection*, SRB Technologies (Canada) Inc., Revision 1, May 2016
- [18] Letter from S. Levesque (SRBT) to L. Posada (CNSC), *Submission of SRBT Environmental Risk Assessment (ERA)*, dated December 23, 2020
- [19] Letter from L. Posada (CNSC) to S. Levesque (SRBT), *CNSC Staff Review of SRB Technologies (Canada) Inc.'s Environmental Risk Assessment*, dated March 12, 2021.
- [20] Letter from L. Posada (CNSC) to S. Levesque (SRBT), *CNSC Staff Follow-up Review of SRB Technologies (Canada) Inc.'s Environmental Risk Assessment*, dated April 22, 2021.
- [21] SRBT Safety Analysis Report, Revision 5, December 2023
- [22] Klose, S (Ontario Ministry of the Environment), *Certificate of Approval – Air – Number 5310-4NJQE2*, August 31, 2000
- [23] SRBT Environmental Monitoring Program, Revision C, Section 2.2, July 31, 2021
- [24] Morris, N, *Derived Release Limits for The SRB Pembroke Facility – 2021 Update*, October 30, 2021
- [25] Census information from Statistics Canada website at <https://www12.statcan.gc.ca/>
- [26] Email from Wagner, K (Ontario Ministry of Natural Resources & Forestry) to MacDonald, J. (SRBT), *RE: Info Request – Species at Risk near Pembroke ON*, dated May 13, 2020
- [27] *Valuable Ecosystem Component Selection*, note provided by Two-Axe Kohoko, A., to MacDonald, J. (SRBT), dated October 15, 2020.
- [28] *Bruce Power Environmental Quantitative Risk Assessment*, B-REP-03443-18OCT-2017-01, October 2017, page 319

References, continued...

- [29] *Environmental Risk Assessment Report for Pickering Nuclear*, P-REP-07701-00001 R000, April 2017, page 4.58
- [30] Beresford et al, *Derivation of transfer parameter for use within the ERICA Tool and the default concentration ratios for terrestrial biota*, *Journal of Environmental Radioactivity* 99 (2008), 1393-1407.
- [31] <https://canadasafetycouncil.org/office-noise-and-acoustics/>

8. Appendices

A	Screening Tables: Stressors and Contaminants of Potential Concern
B	Effective Dose Calculations for HHRA - Radiological
C	Profile of Valued Ecosystem Components (VEC)
D	Exposure Values Table for EcoRA
E	VEC Pathway Dose Calculations

APPENDIX A

Screening Tables: Stressors and Contaminants of Potential Concern

Screening Tables: Stressors and Contaminants of Potential Concern

Category - Physical							
Stressor	Facility Process	Pathway	Screening Data	Screening Criteria	Reference	Notes	Carried to Quantitative Assessment?
Facility Noise	General	Auditory due to proximity	52 dB (0700-2300h) 51 dB (2300-0700h)	50 dB (0700-2300h) 45 dB (2300-0700h)	[A1]	Measurements taken September 10-11, 2020 at six points surrounding the facility at the boundary of the area under control of SRBT.	YES
Artificial Lighting	General	Visual due to proximity	Undefined	Undefined	N/A	Ambient lighting around the facility is not excessive. Some added lighting for security assurance. Lighting levels are similar to other commercial / residentially lit homes in the area, and the facility is situated in a semi-urban environment that is already artificially lit.	NO
Vehicular Impacts	General	Injury / death risk to local animals due to vehicular interactions	No known incidents	N/A	N/A	Facility does not have dedicated roadways, and has a relatively small physical footprint compared to other facilities. Coupled with the lack of animal life in the areas affected by vehicular traffic, no significant risk is expected. There is no known or recorded history of animal / vehicle interactions on the site.	NO
Bird Strikes	General	Bird injury / death due to striking facility edifice during flight	No known incidents	N/A	N/A	There are no known or recorded instances where a bird strike had occurred. The planar footprint of the building and associated ventilation stacks, fences, window etc. are not significant, and there are no known bird migration routes or paths that intersect with the physical facility.	NO

Category - Radiological							
Stressor	Facility Process	Pathway	Screening Data	Screening Criteria	Reference	Notes	Carried to Quantitative Assessment?
Tritium Oxide (HTO, T2O vapour)	Tritium Processing	Gaseous Effluent, Liquid Effluent	>10 µSv / year remotely possible EcoRA risk uncharacterized	>5 µSv / year (HHRA) >100 µGy / hour (EcoRA)	[A2] [A3]	Characterized weekly via Effluent Monitoring Program. Limited in amount authorized for release by licence. Action levels in place to provide additional measure of protection and ensure programmatic control. Tracked and trended by Mitigation Committee and program owners. Reported via ACR.	YES
Elemental / Molecular Tritium (T2 gas)	Tritium Processing	Gaseous Effluent, Liquid Effluent	>10 µSv / year remotely possible EcoRA risk uncharacterized	>5 µSv / year (HHRA) >100 µGy / hour (EcoRA)	[A2] [A3]	Characterized weekly via Effluent Monitoring Program. Limited in amount authorized for release by licence. Action levels in place to provide additional measure of protection and ensure programmatic control. Tracked and trended by Mitigation Committee and program owners. Reported via ACR.	YES
Organically-bound Tritium (OBT)	N/A – synthesized by organisms	N/A	>10 µSv / year remotely possible EcoRA risk uncharacterized	>5 µSv / year (HHRA) >100 µGy / hour (EcoRA)	[A3]	OBT is measured in some cases as part of EMP; in other cases, can be derived based on HTO measurements in media and organisms. Included as a COPC despite not being directly introduced into the environment by the facility.	YES
Depleted Uranium	Tritium Processing	Gaseous Effluent	< 0.000045 µg / m ³	>0.01 µg / m ³	[A4]	Potential for exceedingly small amount of DU releases through tritium processing equipment over the course of normal operations due to the application of vacuum pressures on uranium tritide matrix. Substance not monitored as part of EffMP as a matter of routine, as the mass of DU ejected to the environment is well below levels of significance, as per in-house assessment.	NO

References:

- [A1] Screening criteria based on Table B-2 of *Environmental Noise Guideline – Stationary and Transportation Sources – Approval and Planning (NPC-300)* at <https://www.ontario.ca/page/environmental-noise-guideline-stationary-and-transportation-sources-approval-and-planning>. Facility is deemed to fall within definition of a Class 2 area as it lies on the margin of urban / rural development.
- [A2] Represents 50% of the accepted 'de minimis' dose level of 10 µSv / year for application of further ALARA action. SRBT releases routinely expose persons to much less than this value; however, if HTO and molecular species were released up to licence limits in any given year, this dose is likely to be exceeded.
- [A3] As per recommendations in CSA N288.6-12 / UNSCEAR 2008. Value is typically applied for terrestrial biota, but will be applied for all biota, as it bounds the benchmarking value recommended for aquatic biota (400 µGy / hour).
- [A4] Selected DU screening criteria is 1% of current facility action level for BWXT Nuclear Energy Canada – Peterborough. Measurement of DU in SRBT gaseous effluent streams taken via air sampling and filter analysis. Report on file from University of Ottawa Department of Earth Sciences.

Category – Non-Radiological / Conventional / Chemical							
Stressor	Facility Process	Pathway	Screening Data	Screening Criteria	Reference	Notes	Carried to Quantitative Assessment?
Respirable dust – ZnS powder	Coating	Airborne, industrial gaseous effluent	0.14 mg/m ³	3 mg/m ³	[A5]	Screening data and criteria are for occupational exposures. Human exposures outside of SRBT expected to be significantly lower in magnitude. With respect to ecological toxicity, research suggests low impact in aquatic environments below in the ug/L range for ZnS (ref: <i>Toxicity Evaluation of Quantum Dots (ZnS and CdS) Singly and Combined in Zebrafish (Danio rerio)</i> , Int. J. Environ. Res. Public Health, 28 December 2019. Material is filtered by maintained ventilation system, with no significant environmental dispersion expected that could feasibly result in such ecological concentrations.	NO
Ethyl Ether	Coating	Airborne, industrial gaseous effluent	4.88 µg/m ³	30,000 µg/m ³	[A6]	Screening criteria are 'point-of-impingement' concentrations, while screening data are 'point of release' concentrations. Screening criteria taken from MOE Certification Package.	NO
Phosphoric acid	Coating	Airborne, industrial gaseous effluent	4.45 µg/m ³	100 µg/m ³	[A6]	Screening criteria are 'point-of-impingement' concentrations, while screening data are 'point of release' concentrations. Screening criteria taken from MOE Certification Package.	NO
Hydrofluoric acid	Coating – washing	Airborne, industrial gaseous effluent	8.84 µg/m ³	17 µg/m ³	[A6]	Screening criteria are 'point-of-impingement' concentrations, while screening data are 'point of release' concentrations. Screening criteria taken from MOE Certification Package.	NO
Ethanol	Assembly – device manufacture	Airborne, industrial gaseous effluent	0.12 µg/m ³	19,000 µg/m ³	[A6]	Screening criteria are 'point-of-impingement' concentrations, while screening data are 'point of release' concentrations. Screening criteria taken from MOE Certification Package.	NO
Methyl Ethyl Ketone	Silk Screening	Airborne, industrial gaseous effluent	3.41 µg/m ³	31,000 µg/m ³	[A6]	Screening criteria are 'point-of-impingement' concentrations, while screening data are 'point of release' concentrations. Screening criteria taken from MOE Certification Package.	NO
Methyl Alcohol	Silk Screening	Airborne, industrial gaseous effluent	3.41 µg/m ³	84,000 µg/m ³	[A6]	Screening criteria are 'point-of-impingement' concentrations, while screening data are 'point of release' concentrations. Screening criteria taken from MOE Certification Package.	NO
Acetone	Silk Screening	Airborne, industrial gaseous effluent	42.69 µg/m ³	48,000 µg/m ³	[A6]	Screening criteria are 'point-of-impingement' concentrations, while screening data are 'point of release' concentrations. Screening criteria taken from MOE Certification Package. With respect to ecological toxicity, critical toxicity value cited in research by Environment Canada also notes 122 mg/m ³ in urban air as being 'predicted no-effect limit'. As such, point-of-release concentration associated with this process can be screened out with respect to effect on ecological components.	NO
Toluene	Silk Screening	Airborne, industrial gaseous effluent	3.41 µg/m ³	2,000 µg/m ³	[A6]	Screening criteria are 'point-of-impingement' concentrations, while screening data are 'point of release' concentrations. Screening criteria taken from MOE Certification Package.	NO
Glycol Ether DB	Screen washing	Airborne, industrial gaseous effluent	3.73 µg/m ³	65 µg/m ³	[A6]	Screening criteria are 'point-of-impingement' concentrations, while screening data are 'point of release' concentrations. Screening criteria taken from MOE Certification Package.	NO
Methyl-Pyrrolidone	Screen washing	Airborne, industrial gaseous effluent	0.44 µg/m ³	40,000 µg/m ³	[A6]	Screening criteria are 'point-of-impingement' concentrations, while screening data are 'point of release' concentrations. Screening criteria taken from <i>Summary of Point of Impingement Standards</i> , Ontario MOE, 2001.	NO
Glautine Laurate Glycols	Screen washing	Airborne, industrial gaseous effluent	0.81 µg/m ³	ND – see notes	[A6]	Surfactant component from screen washing process. Similar surfactants have allowable daily intake values of 25 mg/kg body weight per day (source: World Health Organization as referenced in Canadian Soil Quality Guidelines for the Protection for Environmental and Human Health Fact Sheet for propylene glycol) These levels are very unlikely to be seen in human or ecological receptors at the analysed rate of release.	NO
Emulsifier	Screen washing	Airborne, industrial gaseous effluent	0.31 µg/m ³	ND – see notes	[A6]	Surfactant component from screen washing process. Similar surfactants have allowable daily intake values of 25 mg/kg body weight per day (source: World Health Organization as referenced in Canadian Soil Quality Guidelines for the Protection for Environmental and Human Health Fact Sheet for propylene glycol) These levels are very unlikely to be seen in human or ecological receptors at the analysed rate of release.	NO
Petroleum distillate	Screen washing	Airborne, industrial gaseous effluent	1.24 µg/m ³	2,600 µg/m ³	[A6]	Screening criteria are 'point-of-impingement' concentrations, while screening data are 'point of release' concentrations. Screening criteria is 24 hour Schedule 3 value for mineral spirits, taken from O.Reg 419/05.	NO
Alkylphenol-ethoxylate	Screen washing (emulsion removal)	Airborne, industrial gaseous effluent	0.51 µg/m ³	ND – see notes	[A6]	Screening criteria are 'point-of-impingement' concentrations, while screening data are 'point of release' concentrations. Surfactant component from screen washing process. Similar surfactants have allowable daily intake values of 25 mg/kg body weight per day (source: World Health Organization as referenced in Canadian Soil Quality Guidelines for the Protection for Environmental and Human Health Fact Sheet for propylene glycol) These levels are very unlikely to be seen in human or ecological receptors at the analysed rate of release.	NO

Stressor	Facility Process	Pathway	Screening Data	Screening Criteria	Reference	Notes	Carried to Quantitative Assessment?
Sodium metaperiodate	Screen washing (emulsion removal)	Airborne, industrial gaseous effluent	0.24 µg/m ³	ND – see notes	[A6]	Screening criteria are 'point-of-impingement' concentrations, while screening data are 'point of release' concentrations. Surfactant component from screen washing process. Similar surfactants have allowable daily intake values of 25 mg/kg body weight per day (source: World Health Organization as referenced in Canadian Soil Quality Guidelines for the Protection for Environmental and Human Health Fact Sheet for propylene glycol) These levels are very unlikely to be seen in human or ecological receptors at the analysed rate of release.	NO
Sodium hydroxide	Screen rejuvenation	Airborne, industrial gaseous effluent	0.44 µg/m ³	10 µg/m ³	[A6]	Screening criteria are 'point-of-impingement' concentrations, while screening data are 'point of release' concentrations. Component of screen rejuvenator as per SDS. Screening criteria taken from <i>Summary of Point of Impingement Standards</i> , Ontario MOE, 2001.	NO
Sodium chloride	Screen rejuvenation	Airborne, industrial gaseous effluent	0.44 µg/m ³	ND – see notes	[A6]	Screening criteria are 'point-of-impingement' concentrations, while screening data are 'point of release' concentrations. Component of screen rejuvenator as per SDS. Common salt. Sodium chloride at routine release rates is extremely unlikely to be of concern based on ubiquitous in the environment (i.e. routine use for road de-icing).	NO
Sodium hypochlorite	Screen rejuvenation	Airborne, industrial gaseous effluent	0.44 µg/m ³	2,000 µg/m ³	[A6]	Screening criteria are 'point-of-impingement' concentrations, while screening data are 'point of release' concentrations. Component of screen rejuvenator as per SDS. Common bleach. Screening criteria taken from American Industrial Hygiene Association.	NO
Isophorone	Silk screening – ink application	Airborne, industrial gaseous effluent	1.33 µg/m ³	28,000 µg/m ³	[A6]	Screening criteria are 'point-of-impingement' concentrations, while screening data are 'point of release' concentrations. Component of silk screening ink as per SDS. Screening criteria taken from SDS for Ontario TWA for GVI Ink	NO
Cyclosol-63	Silk screening – ink application	Airborne, industrial gaseous effluent	1.33 µg/m ³	78,000 µg/m ³	[A6]	Screening criteria are 'point-of-impingement' concentrations, while screening data are 'point of release' concentrations. Component of silk screening ink as per SDS. Screening criteria taken from SDS for Ontario TWA for GVI Ink	NO
Glycol ether acetate	Silk screening – ink application	Airborne, industrial gaseous effluent	0.22 µg/m ³	26 µg/m ³	[A6]	Screening criteria are 'point-of-impingement' concentrations, while screening data are 'point of release' concentrations. Component of silk screening ink as per SDS. Screening criteria taken from US EPA regional screening levels, industrial air concentration for 2-ethoxyethyl acetate.	NO
Diacetone alcohol	Silk screening – ink application	Airborne, industrial gaseous effluent	0.44 µg/m ³	990 µg/m ³	[A6]	Screening criteria are 'point-of-impingement' concentrations, while screening data are 'point of release' concentrations. Component of silk screening ink as per SDS. Screening criteria taken from MOE Certification Package.	NO
Butyrolactone	Silk screening – ink application	Airborne, industrial gaseous effluent	0.44 µg/m ³	280 µg/m ³	[A6]	Screening criteria are 'point-of-impingement' concentrations, while screening data are 'point of release' concentrations. Component of silk screening ink. Screening criteria taken from Michigan Department of Environmental Quality, 1999.	NO
Glycol ether EB	Ink / paint thinning	Airborne, industrial gaseous effluent	0.72 µg/m ³	350 µg/m ³	[A6]	Screening criteria are 'point-of-impingement' concentrations, while screening data are 'point of release' concentrations. Component of slow thinner as per SDS. Screening criteria taken from MOE Certification Package.	NO
Pumice – powder	Silk screening – screen cleaning	Airborne, industrial gaseous effluent	0.07 µg/m ³	ND – see notes	[A6]	Screening criteria are 'point-of-impingement' concentrations, while screening data are 'point of release' concentrations. Component of screen mesh abrader as per SDS. Commonly used abrasive, non-toxic. At derived concentration level, can be screened out with a high level of confidence due to understood benign nature of the material.	NO
Acetone	Sign Assembly	Airborne, industrial gaseous effluent	7.3 ppm	250 ppm	[A7]	Screening data and criteria are for occupational exposures. Human exposures outside of SRBT certain to be significantly lower in magnitude. With respect to ecological toxicity, value cited in research by Environment Canada notes 122 mg/m ³ in urban air as being 'predicted no-effect limit'. Conversion is 7.3 ppm = 18.24 mg/m ³ ; ergo, even at occupational levels can be screened out with respect to effect on ecological components.	NO
Tetrahydrofuran	Sign Assembly	Airborne, industrial gaseous effluent	0.3 ppm	50 ppm	[A7]	Screening data and criteria are for occupational exposures. Human exposures outside of SRBT certain to be significantly lower in magnitude. With respect to ecological toxicity, US EPA regional screening level for industrial air is 880 µg/m ³ . Conversion of occupational exposure concentration of 0.3 ppm equates roughly to 885 µg/m ³ , which does not factor concentration at the point of release after dilution via ventilation. As such, can be screened out as point-of-impingement concentrations will be far lower.	NO

Stressor	Facility Process	Pathway	Screening Data	Screening Criteria	Reference	Notes	Carried to Quantitative Assessment?	
Propylene	Molding – Lexan	Airborne, industrial gaseous effluent	32 ppb	500,000 ppb	[A8]	Screening data and criteria are for occupational exposures. Human exposures outside of SRBT certain to be significantly lower in magnitude.	NO	
N-Butane	Molding – Lexan	Airborne, industrial gaseous effluent	80 ppb	1,000,000 ppb	[A8]		NO	
Ethanol	Molding – Lexan	Airborne, industrial gaseous effluent	33 ppb	1,000,000 ppb	[A8]		NO	
Acetonitrile	Molding – Lexan	Airborne, industrial gaseous effluent	9.4 ppb	20,000 ppb	[A8]		NO	
Acetone	Molding – Lexan	Airborne, industrial gaseous effluent	170 ppb	250,000 ppb	[A8]		NO	
Isopropyl Alcohol	Molding – Lexan	Airborne, industrial gaseous effluent	43 ppb	200,000 ppb	[A8]		NO	
Pentane	Molding – Lexan	Airborne, industrial gaseous effluent	1.5 ppb	1,000,000 ppb	[A8]		NO	
Freon-113	Molding – Lexan	Airborne, industrial gaseous effluent	2.6 ppb	1,000,000 ppb	[A8]		NO	
Vinyl Acetate	Molding – Lexan	Airborne, industrial gaseous effluent	19 ppb	10,000 ppb	[A8]		NO	
Methyl Ethyl Ketone	Molding – Lexan	Airborne, industrial gaseous effluent	1.5 ppb	200,000 ppb	[A8]		NO	
Hexane	Molding – Lexan	Airborne, industrial gaseous effluent	140 ppb	500,000 ppb	[A8]		NO	
Ethyl Acetate	Molding – Lexan	Airborne, industrial gaseous effluent	46 ppb	400,000 ppb	[A8]		NO	
Cyclohexane	Molding – Lexan	Airborne, industrial gaseous effluent	2 ppb	100,000 ppb	[A8]		NO	
Toluene	Molding – Lexan	Airborne, industrial gaseous effluent	7 ppb	20,000 ppb	[A8]		With respect to screening for ecological risks for both Lexan and ABS molding, total expected risk can be reasonably bounded by the risk associated with emission of the two limiting components assessed for human exposure – acetonitrile and vinyl acetate.	NO
Meta- & Para-Xylene	Molding – Lexan	Airborne, industrial gaseous effluent	3.1 ppb	100,000 ppb	[A8]		NO	
Styrene	Molding – Lexan	Airborne, industrial gaseous effluent	8.4 ppb	50,000 ppb	[A8]		NO	
Ortho-Xylene	Molding – Lexan	Airborne, industrial gaseous effluent	0.9 ppb	100,000 ppb	[A8]		For acetonitrile a 'no effect' level of 1,500,000 ppb is cited in the literature (https://www.canada.ca/en/environment-climate-change/services/evaluating-existing-substances/screening-assessment-acetonitrile.html). Compare this with the maximum value of 13 ppb measured.	NO
1,2,4-Trimethylbenzene	Molding – Lexan	Airborne, industrial gaseous effluent	2.4 ppb	25,000 ppb	[A8]		NO	
TIC: Pentane, 3 Methyl	Molding – Lexan	Airborne, industrial gaseous effluent	85 ppb	500,000 ppb	[A8]		For vinyl acetate a 'no effect' level of 50,000 ppb is cited in the literature (https://www.ec.gc.ca/ees-ees/default.asp?lang=En&n=E41E17F4-1) for chronic toxicity / carcinogenicity over two years. Compare this with the maximum value of 19 ppb measured.	NO
TIC: Cyclopentane, Methyl	Molding – Lexan	Airborne, industrial gaseous effluent	36 ppb	500,000 ppb	[A8]		NO	
Propylene	Molding – ABS	Airborne, industrial gaseous effluent	11 ppb	500,000 ppb	[A8]	Given these relative low values for these two limiting contaminants, it is reasonable to screen out ecological risks associated with remaining measured contaminants associated with injection molding of ABS and Lexan, especially considering that ventilation dilution factors are not accounted for, and true point-of-impingement concentrations values are expected to be orders of magnitude lower outside of the facility.	NO	
Chloromethane	Molding – ABS	Airborne, industrial gaseous effluent	0.8 ppb	50,000 ppb	[A8]		NO	
N-Butane	Molding – ABS	Airborne, industrial gaseous effluent	33 ppb	1,000,000 ppb	[A8]		NO	
Ethanol	Molding – ABS	Airborne, industrial gaseous effluent	140 ppb	1,000,000 ppb	[A8]		NO	
Acetonitrile	Molding – ABS	Airborne, industrial gaseous effluent	13 ppb	20,000 ppb	[A8]		NO	
Acetone	Molding – ABS	Airborne, industrial gaseous effluent	67 ppb	250,000 ppb	[A8]		NO	
Isopropyl Alcohol	Molding – ABS	Airborne, industrial gaseous effluent	78 ppb	200,000 ppb	[A8]		NO	
Pentane	Molding – ABS	Airborne, industrial gaseous effluent	1.8 ppb	1,000,000 ppb	[A8]		NO	
Freon-113	Molding – ABS	Airborne, industrial gaseous effluent	2.5 ppb	1,000,000 ppb	[A8]		NO	
Vinyl Acetate	Molding – ABS	Airborne, industrial gaseous effluent	5.3 ppb	10,000 ppb	[A8]		NO	
Methyl Ethyl Ketone	Molding – ABS	Airborne, industrial gaseous effluent	1.1 ppb	200,000 ppb	[A8]	NO		
Hexane	Molding – ABS	Airborne, industrial gaseous effluent	40 ppb	500,000 ppb	[A8]	NO		
Ethyl Acetate	Molding – ABS	Airborne, industrial gaseous effluent	29 ppb	400,000 ppb	[A8]	NO		
Toluene	Molding – ABS	Airborne, industrial gaseous effluent	8.9 ppb	20,000 ppb	[A8]	NO		

Stressor	Facility Process	Pathway	Screening Data	Screening Criteria	Reference	Notes	Carried to Quantitative Assessment?
Meta- & Para-Xylene	Molding – ABS	Airborne, industrial gaseous effluent	2.8 ppb	100,000 ppb	[A8]	Screening data and criteria are for occupational exposures. Human exposures outside of SRBT certain to be significantly lower in magnitude. With respect to screening for ecological risks for both Lexan and ABS molding, total expected risk can be reasonably bounded by the risk associated with emission of the two limiting components assessed for human exposure – acetonitrile and vinyl acetate. For acetonitrile a 'no effect' level of 1,500,000 ppb is cited in the literature (https://www.canada.ca/en/environment-climate-change/services/evaluating-existing-substances/screening-assessment-acetonitrile.html). Compare this with the maximum value of 13 ppb measured. For vinyl acetate a 'no effect' level of 50,000 ppb is cited in the literature (https://www.ec.gc.ca/ese-ees/default.asp?lang=En&n=E41E17F4-1) for chronic toxicity / carcinogenicity over two years. Compare this with the maximum value of 19 ppb measured. Given these relative low values for these two limiting contaminants, it is reasonable to screen out ecological risks associated with remaining measured contaminants associated with injection molding of ABS and Lexan, especially considering that ventilation dilution factors are not accounted for, and true point-of-impingement concentrations values are expected to be orders of magnitude lower outside of the facility.	NO
Styrene	Molding – ABS	Airborne, industrial gaseous effluent	11 ppb	50,000 ppb	[A8]		NO
Ortho-Xylene	Molding – ABS	Airborne, industrial gaseous effluent	0.9 ppb	100,000 ppb	[A8]		NO
Nonane	Molding – ABS	Airborne, industrial gaseous effluent	1.1 ppb	200,000 ppb	[A8]		NO
1,2,4-Trimethylbenzene	Molding – ABS	Airborne, industrial gaseous effluent	3.2 ppb	25,000 ppb	[A8]		NO
Naphthalene	Molding – ABS	Airborne, industrial gaseous effluent	1.2 ppb	10,000 ppb	[A8]		NO
TIC: Pentane, 3 Methyl	Molding – ABS	Airborne, industrial gaseous effluent	22 ppb	500,000 ppb	[A8]		NO
TIC: Cyclopentane, Methyl	Molding – ABS	Airborne, industrial gaseous effluent	9.4 ppb	500,000 ppb	[A8]		NO
Combustion gases – natural gas	Building heating	Airborne, industrial gaseous effluent	0.48 MJ/h	10.5 GJ/h	[A9]		Reasonable screening criteria in the absence of regulatory requirements or specific guidance for small scale industrial / manufacturing facilities.
Combustion gases – propane	Tritium processing – trap heating	Airborne, industrial gaseous effluent	68 kg CO ₂ per year.	2,000 kg of CO ₂ per year	[A9]	Reasonable screening criteria in the absence of regulatory requirements or specific guidance for small scale industrial / manufacturing facilities.	NO
Combustion gases – acetylene	Tritium processing – light sealing	Airborne, industrial gaseous effluent	88 kg CO ₂ per year	2,000 kg of CO ₂ per year	[A9]	Reasonable screening criteria in the absence of regulatory requirements or specific guidance for small scale industrial / manufacturing facilities.	NO
Argon	Tritium processing – purge gas	Airborne, industrial gaseous effluent	<0.0003% increase argon in air	100% increase argon in air	[A9]	Reasonable screening criteria in the absence of regulatory requirements or specific guidance for small scale industrial / manufacturing facilities.	NO
Nitrogen	Coating – purge gas	Airborne, industrial gaseous effluent	0.005% decrease in O conc.	<1% decrease in O conc.	[A9]	Reasonable screening criteria in the absence of regulatory requirements or specific guidance for small scale industrial / manufacturing facilities.	NO
Nitrogen	Tritium processing – pressurized light source manufacturing	Airborne, industrial gaseous effluent	0.13% decrease in O conc.	<1% decrease in O conc.	[A9]	Reasonable screening criteria in the absence of regulatory requirements or specific guidance for small scale industrial / manufacturing facilities.	NO
Chloroform	Assembly – plastic case sealing	Airborne, industrial gaseous effluent	0.63 µg/m ³	1 µg/m ³	[A9]	Screening criteria is 24 hour Schedule 3 value at point of impingement, taken from O.Reg 419/05.	NO
Nitric acid	Tritium Trap preparation	Airborne, industrial gaseous effluent	0.2 µg/m ³	35 µg/m ³	[A9]	Screening criteria is 24 hour Schedule 3 value at point of impingement, taken from O.Reg 419/05.	NO
Ethyl Ether	Tritium Processing – Leak Diagnosis	Airborne, industrial gaseous effluent	90 µg/m ³	8,000 µg/m ³	[A9]	Screening criteria is 24 hour Schedule 3 value at point of impingement, taken from O.Reg 419/05.	NO
Mixed VOCs	3D printing	Airborne, industrial gaseous effluent	12.63 µg/m ³	400 µg/m ³	[A9]	Screening criteria listed is 20% of Ontario ambient air quality guideline for toluene.	NO
Acetone	Coating	Liquid effluent	30.5 µg/L	32,000 µg/L	[A9]	Screening criteria listed is 20% of predicted federal no-effect concentration for freshwater species.	NO
Hydrofluoric acid	Coating	Liquid effluent	2.21 µg/L	24 µg/L	[A9]	Screening criteria listed is 20% of water quality guideline for inorganic fluorides derived by CCME.	NO
Isopropyl alcohol	Coating	Liquid effluent	30.3 µg/L	60 µg/L	[A9]	Screening criteria listed is 20% of listed Ontario water quality guideline.	NO

References:

- [A5] Air Quality Monitoring for Acids, Solvents and Respirable Dust in Silk Screening Area and Coating Room, Water and Earth Science Associated Ltd., July 2003
- [A6] Certificate of Approval – Air; Number 5310-4NJQE2; certification application package and analyses submitted to Ontario Ministry of the Environment, May 2000
- [A7] Respiratory Protection Program CSA Z94.4-13 Compliance, Auspice Safety Inc., September 2015
- [A8] Industrial Hygiene Assessment, EHS Partnerships Ltd., June 2019
- [A9] See SRBT ERA – Revision B, Appendix B

APPENDIX B**Effective Dose Calculations for HHRA – Radiological**

The dose assessed for selected groups of representative persons is a summation of:

- Tritium uptake from inhalation and immersion in air at the place of residence and/or the place of work, ($P_{(i)19}$ and $P_{(e)19}$),
- Tritium uptake due to immersion in well water ($P_{(e)29}$),
- Tritium uptake due to ingestion of well water ($P_{(i)29}$),
- Tritium uptake due to ingestion of produce (P_{49}), and
- Tritium uptake due to ingestion of dairy products (P_{59}).

LOCAL RESIDENTS OF PEMBROKE

Exposure factors are as follows, based upon N288.1-14 listed parameters.

Exposure Factor	Units	Adult	Infant (1 yr.)	Child (10 yr.)
Inhalation rate	m ³ /a	8,400	2,740	7,850
Worker inhalation rate*	m ³ /a	10,512	-	-
Drinking water intake rate	L/a	1,081	306	482
Produce intake rate – commercial	kg/a	289	87	186
Produce intake rate – residential	kg/a	124	37	80
Animal produce intake rate (milk)	kg/a	189	340	320

(*derived from ICRP 119)

Effective dose coefficients are as follows (from N288.1-14):

Age Group	Effective Dose Coefficient – Inhalation (HTO) (μSv/Bq)	Effective Dose Coefficient – Ingestion (HTO) (μSv/Bq)	Effective Dose Coefficient – Ingestion (OBT) (μSv/Bq)	Effective Dose Coefficient – Immersion (HTO) (μSv/a per Bq/L)
Adult	3.0E-5	2.0E-5	4.6E-5	2.58E-4
Infant	8.0E-5	5.3E-5	1.3E-4	5.61E-5
Child	3.8E-5	2.5E-5	6.3E-5	2.15E-4

Dose due to inhalation

Input parameters:

- **49 Bq/m³** for residential (based on max. measurement of 24.40 at NW250 in Nov. 2015)
- **39 Bq/m³** for occupational (based on max. measurement of 19.46 at PAS 2 in Nov. 2024)

P_{(i)19}: Adult worker dose due to HTO inhaled at residence and workplace (as per equation 6-79 from CSA N288.1-14)

Assumption of 76.256% of time spent at residence, with remainder spent at workplace (i.e. the worker is working for 40 hours per week during an average calendar year of 365.25 days).

Residential component:

$$\begin{aligned} P_{(i)19r} &= [H-3_{air}] \text{ (Bq/m}^3\text{)} \times \text{Resp. Rate (m}^3\text{/a)} \times \text{Occup. Factor} \times \text{DCF}_{H3} \text{ (}\mu\text{Sv/Bq)} \\ &= 49 \text{ Bq/m}^3 \times 8,400 \text{ m}^3\text{/a} \times 0.76256 \times 3.0\text{E-}05 \mu\text{Sv/Bq} \\ &= 9.42 \mu\text{Sv/a} \end{aligned}$$

Workplace component:

$$\begin{aligned} P_{(i)19w} &= [H-3_{air}] \text{ (Bq/m}^3\text{)} \times \text{Resp. Rate (m}^3\text{/a)} \times \text{Occup. Factor} \times \text{DCF}_{H3} \text{ (}\mu\text{Sv/Bq)} \\ &= 39 \text{ Bq/m}^3 \times 10,512 \text{ m}^3\text{/a} \times 0.23744 \times 3.0\text{E-}05 \mu\text{Sv/Bq} \\ &= 2.92 \mu\text{Sv/a.} \end{aligned}$$

P_{(i)19}: Adult resident dose due to HTO inhaled at residence

Assumption of 100% of time spent at residence:

$$\begin{aligned} P_{(i)19} &= [H-3_{air}] \text{ (Bq/m}^3\text{)} \times \text{Resp. Rate (m}^3\text{/a)} \times \text{DCF}_{H3} \text{ (}\mu\text{Sv/Bq)} \\ &= 49 \text{ Bq/m}^3 \times 8,400 \text{ m}^3\text{/a} \times 3.0\text{E-}05 \mu\text{Sv/Bq} \\ &= 12.35 \mu\text{Sv/a} \end{aligned}$$

P_{(i)19}: Infant resident dose due to HTO inhaled at residence

Assumption of 100% of time spent at residence:

$$\begin{aligned} P_{(i)19} &= [H-3_{air}] \text{ (Bq/m}^3\text{)} \times \text{Resp. Rate (m}^3\text{/a)} \times \text{DCF}_{H3} \text{ (}\mu\text{Sv/Bq)} \\ &= 49 \text{ Bq/m}^3 \times 2,740 \text{ m}^3\text{/a} \times 8.0\text{E-}05 \mu\text{Sv/Bq} \\ &= 10.74 \mu\text{Sv/a} \end{aligned}$$

P_{(i)19}: Child resident dose due to HTO inhaled at residence

Assumption of 100% of time spent at residence:

$$\begin{aligned} P_{(i)19} &= [H-3_{air}] \text{ (Bq/m}^3\text{)} \times \text{Resp. Rate (m}^3\text{/a)} \times \text{DCF}_{H3} \text{ (}\mu\text{Sv/Bq)} \\ &= 49 \text{ Bq/m}^3 \times 7,850 \text{ m}^3\text{/a} \times 3.8\text{E-}05 \mu\text{Sv/Bq} \\ &= 14.62 \mu\text{Sv/a} \end{aligned}$$

Dose due to atmospheric skin absorption

Dose due to atmospheric skin absorption of moisture in air is implicitly included in the inhalation dose conversion factors applied above, as per CSA N288.1-14, Table C.1 footnote.

Dose due to immersion in water – bathing and swimming

Dose due to immersion in bath or swimming pool water is derived using the default values for the transfer parameter, as listed in Table A.20b of CSA N288.1-14.

Input parameter:

- **464 Bq/L** for drinking water used as bathing and swimming pool water (based on max. measurement of 232 Bq/L at RW-8 in Nov. 2015)
 - *NOTE: this well is no longer in use for domestic water use (has been capped).*

P_{(e)29}: Adult dose due to water immersion

$$\begin{aligned}
 P_{(e)29} &= [H-3]_{\text{well}} \times 1.29E-04 \text{ } \mu\text{Sv/Bq}; \\
 &= [464 \text{ Bq/L}] \times 1.29E-04 \text{ } \mu\text{Sv/Bq} \\
 &= 0.06 \text{ } \mu\text{Sv/a}
 \end{aligned}$$

P_{(e)29}: Infant dose due to water immersion

$$\begin{aligned}
 P_{(e)29} &= [H-3]_{\text{well}} \times 5.61E-05 \text{ } \mu\text{Sv/Bq}; \\
 &= [464 \text{ Bq/L}] \times 5.61E-05 \text{ } \mu\text{Sv/Bq} \\
 &= 0.03 \text{ } \mu\text{Sv/a}
 \end{aligned}$$

P_{(e)29}: Child dose due to water immersion

$$\begin{aligned}
 P_{(e)29} &= [H-3]_{\text{well}} \times 1.07E-04 \text{ } \mu\text{Sv/Bq}; \\
 &= [464 \text{ Bq/L}] \times 1.07E-04 \text{ } \mu\text{Sv/Bq} \\
 &= 0.05 \text{ } \mu\text{Sv/a}
 \end{aligned}$$

Dose due to ingestion of well water

(as per equation 7-17 from CSA N288.1-14)

Input parameter:

- **464 Bq/L** for drinking water (based on max. measurement of 232 Bq/L at RW-8 in Nov. 2015)
 - *NOTE: this well is no longer in use for domestic water use (has been capped).*

P_{(i)29}: Adult dose due to consumption of well water

$$\begin{aligned}
 P_{(i)29} &= [H-3]_{\text{well}} \times M \times 2.0E-05 \text{ } \mu\text{Sv/Bq}; \\
 &= [464 \text{ Bq/L}] \times 1,081 \text{ L/a} \times 2.0E-05 \text{ } \mu\text{Sv/Bq} \\
 &= 10.03 \text{ } \mu\text{Sv/a}
 \end{aligned}$$

P_{(i)29}: Infant dose due to consumption of well water

$$\begin{aligned}
 P_{(i)29} &= [H-3]_{\text{well}} \times M \times 5.3E-05 \text{ } \mu\text{Sv/Bq}; \\
 &= [464 \text{ Bq/L}] \times 306 \text{ L/a} \times 5.3E-05 \text{ } \mu\text{Sv/Bq} \\
 &= 7.53 \text{ } \mu\text{Sv/a}
 \end{aligned}$$

P_{(i)29}: Child dose due to consumption of well water

$$\begin{aligned}
 P_{(i)29} &= [H-3]_{\text{well}} \times M \times 2.5E-05 \text{ } \mu\text{Sv/Bq}; \\
 &= [464 \text{ Bq/L}] \times 482 \text{ L/a} \times 2.5E-05 \text{ } \mu\text{Sv/Bq} \\
 &= 5.59 \text{ } \mu\text{Sv/a}
 \end{aligned}$$

Dose due to ingestion of produce

(as per equation 6-81C from CSA N288.1-14)

Input parameters:

- **922 Bq/kg** for HTO in residential produce (based on max measurement of 461 Bq/kg in green onion in 2023)
- **24 Bq/kg** for HTO in commercial produce (based on max measurement of 12 Bq/kg in cucumber in 2019)
- **26 Bq/kg** for OBT in residential produce (based on max measurement of 13 Bq/kg in carrot in 2016)
- **8 Bq/kg** for OBT in commercial produce (based on max measurement of 4 Bq/kg in tomato in 2021)

Tritium oxide in produce component:

P₄₉: Adult dose due to ingestion of produce (HTO)

$$\begin{aligned}
 P_{49\text{HTO}} &= [[H_{\text{prod,market}}] + [H_{\text{prod,res}}]] \times 2.0\text{E-}05 \text{ } \mu\text{Sv/Bq} \\
 &= [[H\text{-}3_{\text{veg}}] (\text{Bq/kg}) \times (\text{kg}_{\text{market}})] + [H\text{-}3_{\text{veg}}] (\text{Bq/kg}) \times (\text{kg}_{\text{res}})] \times 2.0\text{E-}5 \text{ } \mu\text{Sv/Bq} \\
 &= [[24 \text{ Bq/kg} \times 289 \text{ kg/a}] + [922 \text{ Bq/kg} \times 124 \text{ kg/a}]] \times 2.0\text{E-}05 \text{ } \mu\text{Sv/Bq} \\
 &= [6,936 \text{ Bq} + 114,328 \text{ Bq}] \times 2.0\text{E-}05 \text{ } \mu\text{Sv/Bq} \\
 &= 2.43 \text{ } \mu\text{Sv/a}
 \end{aligned}$$

P₄₉: Infant dose due to ingestion of produce (HTO)

$$\begin{aligned}
 P_{49\text{HTO}} &= [[H_{\text{prod,market}}] + [H_{\text{prod,res}}]] \times 5.3\text{E-}05 \text{ } \mu\text{Sv/Bq} \\
 &= [[H\text{-}3_{\text{veg}}] (\text{Bq/kg}) \times (\text{kg}_{\text{market}})] + [H\text{-}3_{\text{veg}}] (\text{Bq/kg}) \times (\text{kg}_{\text{res}})] \times 5.3\text{E-}5 \text{ } \mu\text{Sv/Bq} \\
 &= [[24 \text{ Bq/kg} \times 87 \text{ kg/a}] + [922 \text{ Bq/kg} \times 37 \text{ kg/a}]] \times 5.3\text{E-}05 \text{ } \mu\text{Sv/Bq} \\
 &= [2,088 \text{ Bq} + 34,114 \text{ Bq}] \times 5.30\text{E-}05 \text{ } \mu\text{Sv/Bq} \\
 &= 1.92 \text{ } \mu\text{Sv/a}
 \end{aligned}$$

P₄₉: Child dose due to ingestion of produce (HTO)

$$\begin{aligned}
 P_{49\text{HTO}} &= [[H_{\text{prod,market}}] + [H_{\text{prod,res}}]] \times 2.5\text{E-}05 \text{ } \mu\text{Sv/Bq} \\
 &= [[H\text{-}3_{\text{veg}}] (\text{Bq/kg}) \times (\text{kg}_{\text{market}})] + [H\text{-}3_{\text{veg}}] (\text{Bq/kg}) \times (\text{kg}_{\text{res}})] \times 2.5 \text{ E-}5 \text{ } \mu\text{Sv/Bq} \\
 &= [[24 \text{ Bq/kg} \times 186 \text{ kg/a}] + [922 \text{ Bq/kg} \times 80 \text{ kg/a}]] \times 2.5\text{E-}05 \text{ } \mu\text{Sv/Bq} \\
 &= [4,464 \text{ Bq} + 73,760 \text{ Bq}] \times 2.5\text{E-}05 \text{ } \mu\text{Sv/Bq} \\
 &= 1.96 \text{ } \mu\text{Sv/a}
 \end{aligned}$$

Organically-bound tritium in produce component:

P₄₉: Adult dose due to ingestion of produce (OBT)

$$\begin{aligned}
 P_{49\text{HTO}} &= [[H_{\text{prod,market}}] + [H_{\text{prod,res}}]] \times 4.6\text{E-}05 \text{ } \mu\text{Sv/Bq} \\
 &= [[\text{H-3}_{\text{veg}}] (\text{Bq/kg}) \times (\text{kg}_{\text{market}})] + [\text{H-3}_{\text{veg}}] (\text{Bq/kg}) \times (\text{kg}_{\text{res}})] \times 4.6\text{E-}05 \text{ } \mu\text{Sv/Bq} \\
 &= [[8 \text{ Bq/kg} \times 289 \text{ kg/a}] + [26 \text{ Bq/kg} \times 124 \text{ kg/a}]] \times 4.6\text{E-}05 \text{ } \mu\text{Sv/Bq} \\
 &= [2,312 \text{ Bq} + 3,224 \text{ Bq}] \times 4.6\text{E-}05 \text{ } \mu\text{Sv/Bq} \\
 &= 0.25 \text{ } \mu\text{Sv/a}
 \end{aligned}$$

P₄₉: Infant dose due to ingestion of produce (OBT)

$$\begin{aligned}
 P_{49\text{HTO}} &= [[H_{\text{prod,market}}] + [H_{\text{prod,res}}]] \times 1.3\text{E-}04 \text{ } \mu\text{Sv/Bq} \\
 &= [[\text{H-3}_{\text{veg}}] (\text{Bq/kg}) \times (\text{kg}_{\text{market}})] + [\text{H-3}_{\text{veg}}] (\text{Bq/kg}) \times (\text{kg}_{\text{res}})] \times 1.3\text{E-}04 \text{ } \mu\text{Sv/Bq} \\
 &= [[8 \text{ Bq/kg} \times 87 \text{ kg/a}] + [26 \text{ Bq/kg} \times 37 \text{ kg/a}]] \times 1.3\text{E-}04 \text{ } \mu\text{Sv/Bq} \\
 &= [696 \text{ Bq} + 962 \text{ Bq}] \times 1.3\text{E-}04 \text{ } \mu\text{Sv/Bq} \\
 &= 0.22 \text{ } \mu\text{Sv/a}
 \end{aligned}$$

P₄₉: Child dose due to ingestion of produce (OBT)

$$\begin{aligned}
 P_{49\text{HTO}} &= [[H_{\text{prod,market}}] + [H_{\text{prod,res}}]] \times 6.3\text{E-}05 \text{ } \mu\text{Sv/Bq} \\
 &= [[\text{H-3}_{\text{veg}}] (\text{Bq/kg}) \times (\text{kg}_{\text{market}})] + [\text{H-3}_{\text{veg}}] (\text{Bq/kg}) \times (\text{kg}_{\text{res}})] \times 6.3\text{E-}05 \text{ } \mu\text{Sv/Bq} \\
 &= [[8 \text{ Bq/kg} \times 186 \text{ kg/a}] + [26 \text{ Bq/kg} \times 80 \text{ kg/a}]] \times 6.3\text{E-}05 \text{ } \mu\text{Sv/Bq} \\
 &= [1,488 \text{ Bq} + 2,080 \text{ Bq}] \times 6.3\text{E-}05 \text{ } \mu\text{Sv/Bq} \\
 &= 0.22 \text{ } \mu\text{Sv/a}
 \end{aligned}$$

Total dose due to **ingestion** of produce:

P₄₉: Adult dose due to ingestion of produce (HTO + OBT)

$$\begin{aligned}
 P_{49} &= P_{49\text{HTO}} + P_{49\text{OBT}} \\
 &= 2.43 \text{ } \mu\text{Sv/a} + 0.25 \text{ } \mu\text{Sv/a} \\
 &= 2.68 \text{ } \mu\text{Sv/a}
 \end{aligned}$$

P₄₉: Infant dose due to ingestion of produce (HTO + OBT)

$$\begin{aligned}
 P_{49} &= P_{49\text{HTO}} + P_{49\text{OBT}} \\
 &= 1.92 \text{ } \mu\text{Sv/a} + 0.22 \text{ } \mu\text{Sv/a} \\
 &= 2.14 \text{ } \mu\text{Sv/a}
 \end{aligned}$$

P₄₉: Child dose due to ingestion of produce (HTO + OBT)

$$\begin{aligned}
 P_{49} &= P_{49\text{HTO}} + P_{49\text{OBT}} \\
 &= 1.96 \text{ } \mu\text{Sv/a} + 0.22 \text{ } \mu\text{Sv/a} \\
 &= 2.18 \text{ } \mu\text{Sv/a}
 \end{aligned}$$

Dose due to ingestion of local milk

(as per equation 6-81d from CSA N288.1-14)

Input parameter:

- **16 Bq/kg** for milk (based on max. measurement of 8 Bq/L in September 2024, converted to 7.76 Bq/kg as milk has a density of 0.97 L/kg, and subsequently doubled and rounded up for conservatism)
- **18 Bq OBT/kg** in milk (based on max measurement of 9 Bq OBT/L in September 2023, converted to 8.73 Bq/kg as milk has a density of 0.97 L/kg, and subsequently doubled and rounded up for conservatism)

Tritium oxide in milk component:

P_{59HTO}: Adult dose due to ingestion of milk

$$\begin{aligned} P_{59HTO} &= [H-3]_{\text{dairy}} \times M \times 2.0E-05 \mu\text{Sv/Bq}; \\ &= [16 \text{ Bq/kg}] \times 189 \text{ kg/a} \times 2.0E-05 \mu\text{Sv/Bq} \\ &= 0.061 \mu\text{Sv/a} \end{aligned}$$

P_{59HTO}: Infant dose due to ingestion of milk

$$\begin{aligned} P_{59HTO} &= [H-3]_{\text{dairy}} \times M \times 5.3E-05 \mu\text{Sv/Bq}; \\ &= [16 \text{ Bq/kg}] \times 340 \text{ kg/a} \times 5.3E-05 \mu\text{Sv/Bq} \\ &= 0.288 \mu\text{Sv/a} \end{aligned}$$

P_{59HTO}: Child dose due to ingestion of milk

$$\begin{aligned} P_{59HTO} &= [H-3]_{\text{dairy}} \times M \times 2.5E-05 \mu\text{Sv/Bq}; \\ &= [16 \text{ Bq/kg}] \times 320 \text{ kg/a} \times 2.5E-05 \mu\text{Sv/Bq} \\ &= 0.128 \mu\text{Sv/a} \end{aligned}$$

Organically-bound tritium in milk component:

P_{59OBT}: Adult dose due to ingestion of milk

$$\begin{aligned} P_{59OBT} &= [OBT]_{\text{dairy}} \times M \times 4.6E-05 \mu\text{Sv/Bq}; \\ &= [18 \text{ Bq/kg}] \times 189 \text{ kg/a} \times 4.6E-05 \mu\text{Sv/Bq} \\ &= 0.156 \mu\text{Sv/a} \end{aligned}$$

P_{59OBT}: Infant dose due to ingestion of milk

$$\begin{aligned} P_{59OBT} &= [OBT]_{\text{dairy}} \times M \times 1.3E-04 \mu\text{Sv/Bq}; \\ &= [18 \text{ Bq/kg}] \times 340 \text{ kg/a} \times 1.3E-04 \mu\text{Sv/Bq} \\ &= 0.796 \mu\text{Sv/a} \end{aligned}$$

P_{59OBT}: Child dose due to ingestion of milk

$$\begin{aligned}P_{59OBT} &= [\text{OBT}]_{\text{dairy}} \times M \times 2.5\text{E-}05 \text{ } \mu\text{Sv/Bq}; \\ &= [18 \text{ Bq/kg}] \times 320 \text{ kg/a} \times 6.3\text{E-}05 \text{ } \mu\text{Sv/Bq} \\ &= 0.363 \text{ } \mu\text{Sv/a}\end{aligned}$$

Total dose due to **ingestion** of milk:

P₅₉: Adult dose due to ingestion of milk (HTO + OBT)

$$\begin{aligned}P_{59} &= P_{59\text{HTO}} + P_{59\text{OBT}} \\ &= 0.061 \text{ } \mu\text{Sv/a} + 0.156 \text{ } \mu\text{Sv/a} \\ &= 0.217 \text{ } \mu\text{Sv/a}\end{aligned}$$

P₅₉: Infant dose due to ingestion of milk (HTO + OBT)

$$\begin{aligned}P_{59} &= P_{59\text{HTO}} + P_{59\text{OBT}} \\ &= 0.288 \text{ } \mu\text{Sv/a} + 0.796 \text{ } \mu\text{Sv/a} \\ &= 1.084 \text{ } \mu\text{Sv/a}\end{aligned}$$

P₅₉: Child dose due to ingestion of milk (HTO + OBT)

$$\begin{aligned}P_{59} &= P_{59\text{HTO}} + P_{59\text{OBT}} \\ &= 0.128 \text{ } \mu\text{Sv/a} + 0.363 \text{ } \mu\text{Sv/a} \\ &= 0.491 \text{ } \mu\text{Sv/a}\end{aligned}$$

Sum Total Effective Dose – Residents of Pembroke

Dose Contributor		Adult Worker Annual Dose (μSv/a)	Adult Resident Annual Dose (μSv/a)	Infant Resident Annual Dose (μSv/a)	Child Resident Annual Dose (μSv/a)
Dose Due to Inhalation and Absorption at Work	P _{(l)19}	2.92			
Dose Due to Inhalation and Absorption at Residence	P _{(l)19}	9.42	12.35	10.74	14.62
Dose Due to Immersion in Well Water (Bathing and Swimming)	P _{(e)29}	0.06	0.06	0.03	0.05
Dose Due to Ingestion of Well Water	P _{(i)29}	10.03	10.03	7.53	5.59
Dose Due to Ingestion of Produce (HTO+OBT)	P ₄₉	2.68	2.68	2.14	2.18
Dose Due to Ingestion of Milk (HTO+OBT)	P ₅₉	0.217	0.217	1.084	0.491
EFFECTIVE DOSE (μSv/a)	P_{TOTAL}	25.33	25.34	21.52	22.93
<i>Percentage of Regulatory Effective Dose Limit (1 mSv)</i>		2.53%	2.53%	2.15%	2.29%

WORKER AT THE PPCC

Input parameters:

- **49 Bq/m³** for residential inhalation and absorption (based on max. measurement of 24.40 at NW250 in Nov. 2015, doubled and rounded up for conservatism)
- **7 Bq/m³** for occupational inhalation and absorption (based on max. measurement of 3.09 at PPCC in 2022, doubled and rounded up for conservatism)
- **150 Bq/L** for immersion during work activities (based on max measurement of 75 Bq/L in sludge cake-obtained liquids in Sep. 2022, doubled and rounded up for conservatism).

Dose due to inhalation**P_{(i)19}: PPCC worker dose due to HTO inhaled at residence and workplace**

Assumption of 76.256% of time spent at residence, with remainder spent at workplace (i.e. the worker is working for 40 hours per week during an average calendar year of 365.25 days).

Residential component:

$$\begin{aligned}
 P_{(i)19r} &= [H-3_{air}] \text{ (Bq/m}^3\text{)} \times \text{Resp. Rate (m}^3\text{/a)} \times \text{Occup. Factor} \times \text{DCF}_{H3} \text{ (}\mu\text{Sv/Bq)} \\
 &= 49 \text{ Bq/m}^3 \times 8,400 \text{ m}^3\text{/a} \times 0.76256 \times 3.0\text{E-}05 \mu\text{Sv/Bq} \\
 &= 9.42 \mu\text{Sv/a}
 \end{aligned}$$

Workplace component:

$$\begin{aligned}
 P_{(i)19w} &= [H-3_{air}] \text{ (Bq/m}^3\text{)} \times \text{Resp. Rate (m}^3\text{/a)} \times \text{Occup. Factor} \times \text{DCF}_{H3} \text{ (}\mu\text{Sv/Bq)} \\
 &= 7 \text{ Bq/m}^3 \times 10,512 \text{ m}^3\text{/a} \times 0.23744 \times 3.0\text{E-}05 \mu\text{Sv/Bq} \\
 &= 0.52 \mu\text{Sv/a.}
 \end{aligned}$$

Dose due to skin absorption

Dose due to atmospheric skin absorption of moisture in air is implicitly included in the inhalation dose conversion factors applied above, as per CSA N288.1-14, Table C.1 footnote.

P_{(e)29}: Dose due to immersion at PPCC during work activities

Dose due to immersion at the PPCC is calculated in accordance with CSA N288.1-14, section 6.16.2.

Assumptions:

- Double the concentration in immersion liquids as measured in the associated free-water concentration of sludge cake (measured as 75 Bq/L),
- 95th percentile skin surface area (S_a) of 2.19 m²,
- Diffusion rate for water-wetted skin taken as 105 L/year per m² of skin surface area (D_s)
- Ingestion dose coefficient for adult (DCF_{ing})= 2.0E-05 μ Sv/Bq
- Work occupancy factor of 0.23744 (as with inhalation),
- 20% of working time spent immersed (i.e. $OF_w = 0.23744 \times 0.20 = 0.0475$)

$$\begin{aligned}
 P_{(e)29} &= [H-3] \times S_a \times D_s \times DCF_{ing} \times OF_w \\
 &= [150 \text{ Bq/L}] \times 2.19 \text{ m}^2 \times 105 \text{ L/a per m}^2 \times 2.0\text{E-}05 \text{ } \mu\text{Sv/Bq} \times 0.0475 \\
 &= [150 \text{ Bq/L}] \times 2.18\text{E-}04 \text{ } \mu\text{Sv/a per Bq/L} \\
 &= 0.03 \text{ } \mu\text{Sv/a}
 \end{aligned}$$

Dose due to remaining inputs

Taken to be identical to those of the adult worker / resident.

Sum Total Effective Dose – Worker at PPCC

Dose Contributor		PPCC Worker Annual Dose ($\mu\text{Sv/a}$)
Dose Due to Inhalation and Absorption at Residence	$P_{(I)19}$	9.42
Dose Due to Inhalation and Absorption at Work	$P_{(I)19}$	0.52
Dose Due to Immersion in Well Water at Residence (Bathing and Swimming)	$P_{(eh)29}$	0.06
Dose Due to Immersion in Liquids at Workplace (PPCC)	$P_{(ew)29}$	0.03
Dose Due to Ingestion of Well Water at Residence	P_{29}	10.03
Dose Due to Ingestion of Produce at Residence (HTO+OBT)	P_{49}	2.68
Dose Due to Ingestion of Milk at Residence (HTO+OBT)	P_{59}	0.22
EFFECTIVE DOSE ($\mu\text{Sv/a}$)	P_{TOTAL}	22.96
<i>Percentage of Regulatory Effective Dose Limit (1 mSv)</i>		2.30%

APPENDIX C**Profile of Selected Valued Ecosystem Components (VEC)**

The following table describes the selected VECs for the purposes of the EcoRA:

VEC Category	Representative Species	Rationale
Fish	Lake Sturgeon	Suspected presence; Indigenous importance; listed as Species at Risk in other areas of province
Aquatic plant	Bulrushes	Known presence
Aquatic invertebrate	Benthic invertebrates	Taken as a general category for ecological risk assessment
Amphibian / reptile	Blanding's Turtle	Suspected presence; listed as Species at Risk
Terrestrial invertebrate	Earthworms	Known presence; link with other species, important component of food chains
Riparian bird	Ring-billed Gull	Known presence
Terrestrial bird	Barn Swallow	Known presence; listed as Species at Risk
Riparian mammal	Muskrat	Known presence
Terrestrial mammal	Red Squirrel	Known presence
Terrestrial plant	Butternut Tree	Known presence; Indigenous importance; listed as Species at Risk

Each individual species is profiled below, accompanied by a description of the likely habitat within the scoped area of the ERA.

Lake Sturgeon



The Lake Sturgeon is Canada's largest freshwater fish, weighing up to 180 kilograms and reaching over two metres long. It has an extended snout with four whisker-like organs hanging near the mouth. Its body is covered with large bony plates, pronounced in juveniles but less pronounced in larger fishes.

It is dark to light brown or grey on its back and sides with a lighter belly. Unlike other fish found in Ontario, the Lake Sturgeon has a skeleton made up of cartilage instead of bones. The Lake Sturgeon has ancestral ties to related species dating back 200 million years. It can live more than 100 years.

The Lake Sturgeon lives almost exclusively in freshwater lakes and rivers with soft bottoms of mud, sand or gravel. They are usually found at depths of five to 20 metres. In Ontario, the Lake Sturgeon is typically found in the rivers of the Hudson Bay basin, the Great Lakes basin and their major connecting waterways, including the St. Lawrence River.

Lake Sturgeon are known in Anishinàbemowin as name (pronounced nuh-meh). This fish is culturally important to the Anishinàbeg and represents a valued food source. They were and still are a staple food in the Anishinàbe Algonquin diet during the warmer months of the year.

The database for the area around the facility from the Natural Heritage Information Centre notes that the Lake Sturgeon has been sighted in the area previously; however, the data suggests a very limited number of sightings. It is classified as an endangered species in the Great Lakes – Upper St. Lawrence population.

As such this species is a suspected presence in the area, and is considered to possibly inhabit the Ottawa River.

(Reference: <https://www.ontario.ca/page/lake-sturgeon-species-risk>)

Bulrushes

Otherwise known as a Cattail. Herbaceous, perennial plants (genus *Typha*) of the cattail family (Typhaceae) which grow in marshes and waterways.

The name derives from the cylindrical, brown fruiting spikes. At least eight species exist worldwide, with two in Canada (narrow-leaved cattail, *T. angustifolia*, and common cattail, *T. latifolia*). Clusters of stiff, ribbonlike leaves, up to 3 m (or more) tall, grow from a thick, horizontal rootstock.

The rootstock is a rich source of starch; the succulent, young shoots and green flower spikes are also edible; and the pollen and oil-rich seeds have livestock feed potential. The leaves are tough and pithy, and were used by Aboriginal People to make mats, bags, baskets and clothing. Stems and leaves are suitable for making paper and cloth.

Although there are no recorded sightings in the databases used to identify species of interest for the purposes of the ERA, based on local knowledge it is assumed that they are present in riparian zones within the scoped area.

(Reference: <https://www.thecanadianencyclopedia.ca/en/article/cattail>)

Benthic Invertebrates

Benthic invertebrates are consumers of basal resources (algae, biofilms, organic matter), and secondary consumers. They are the link from basal resources to higher trophic levels, including fish. A crayfish is shown here as an example.

Benthic invertebrates are often assessed in aquatic monitoring programs because they are diverse, generally sedentary, and are responsive to environmental alterations. More importantly they are good indicators of ecosystem productivity and health.

Based on local knowledge it is assumed that there are populations of benthic invertebrates in the wetlands and riparian areas within the scoped area of the ERA.

(Reference: <https://www.ontario.ca/page/benthic-sampling-natural-and-regulated-rivers>)

Blanding's Turtle



The Blanding's Turtle is a medium-sized turtle easily identified by its bright yellow throat and chin. Unlike most Ontario turtles that have wide, flatter shells, the Blanding's Turtle has a domed shell that resembles an army helmet.

Its shell is black to brown with yellow flecks and streaks and can reach 27 centimetres long. Its head and limbs are black-grey and the bottom shell is rich yellow.

Blanding's Turtles live in shallow water, usually in large wetlands and shallow lakes with lots of water plants. It is not unusual, though, to find them hundreds of metres from the nearest water body, especially while they are searching for a mate or traveling to a nesting site.

In Canada, the Blanding's Turtle is separated into the Great Lakes-St. Lawrence population and the Nova Scotia population. Blanding's Turtles can be found throughout southern, central and eastern Ontario.

The mikinàk (turtle) also holds Indigenous cultural significance, through the use of the turtle shell in ceremony, teachings, and even as a source of food.

The database for the area around the facility from the Natural Heritage Information Centre notes that the Blanding's Turtle has been sighted in the area previously; however, the data suggests a very limited number of sightings.

As such this species is a suspected presence in the area, and is considered to possibly inhabit the riparian areas of the Muskrat River.

(Reference: <https://www.ontario.ca/page/blandings-turtle>)

Earthworms



There are thousands of earthworm species in the world but only about 20 in Canada. Those we find across Canada (except in a small area on Vancouver Island) are not native. The original earthworms were wiped out by glacial ice sheets that covered Canada until about 15,000 years ago, Canadian earthworms are immigrants, carried here from Europe by the early settlers on root stocks and in the earthen ballast of ships.

Earthworms are most numerous in fine and medium textured soils (clays and loams). They are less common in sands, gravels and acidic soils. Earthworms breathe through their skin and need to keep it moist to stay alive. Soils that are dry for prolonged periods tend to desiccate worms.

Commonly called nightcrawlers or dew worms, deep burrower *Lumbricus terrestris* are the worms most commonly sold for fish bait. Adults are generally 10 to 30 cm long. They create large vertical, permanent burrows up to 2 meters deep in the soil profile. They pull surface plant residues, and in some cases living plant material, down into the mouth of the burrow to soften and be eaten.

Although there are no recorded sightings in the databases used to identify species of interest for the purposes of the ERA, based on local knowledge it is assumed that they are present within the scoped area.

(Reference: <http://www.omafra.gov.on.ca/english/crops/facts/livingsoil4.htm>)

Ring-billed Gull



The adult Ring-billed Gull is a medium-sized gull, measuring 45 cm from bill to tail, having a 50 cm wingspan and weighing about 0.7 kg.

Its white head, neck, underside and tail contrast with its grey wings (or back when the bird is at rest). The wing-tips are black with white spots and the legs and feet are yellow-green. A black ring encircles its yellow bill near the tip.

The Ring-billed Gull is probably the most prolific gull in North America, and is perhaps more abundant today than ever before. An amazingly adaptable and opportunistic bird, it is equally at home nesting on natural islands or on human-made breakwaters, piers, and waste grounds. The Ring-billed Gull will nest on sand, soil, concrete, slag, boulders, driftwood, or rubble—as long as there is water and food nearby.

The database for the area around the facility from eBird.org notes a number of sightings of Ring-billed Gulls within the scoped area of the ERA.

(Reference: <https://www.hww.ca/en/wildlife/birds/ring-billed-gull.html>)

Barn Swallow



The Barn Swallow is a medium-sized songbird (about 15 to 18 centimetres long). Males have a glossy steel-blue back and upper wings, a rusty-red forehead and throat, a short bill and a broad blue breast band above its tawny underbelly.

The male has long tail feathers which form a distinctive, deep fork and a line of white spots across the outer end of the upper tail. The female's tail feathers are shorter, the blue of her upper parts and breast band are less glossy, and her underside is paler.

Barn Swallows often live in close association with humans, building their cup-shaped mud nests almost exclusively on human-made structures such as open barns, under bridges and in culverts. The species is attracted to open structures that include ledges where they can build their nests, which are often re-used from year to year.

Barn Swallows have experienced a significant decline since the mid-1980s. While there have been losses in the number of available nest sites, such as open barns, and in the amount of foraging habitat in open agricultural areas, the causes of the recent population decline are not well understood. The number of Barn Swallows in Ontario decreased by 65 percent between 1966 and 2009.

The database for the area around the facility from eBird.org notes a number of sightings of Barn Swallows within the scoped area of the ERA. It is classified as a threatened species.

(Reference: <https://www.ontario.ca/page/barn-swallow>)

Muskrat

The muskrat (*Ondatra zibethicus*), the only species in genus *Ondatra* and tribe Ondatrini, is a medium-sized semiaquatic rodent native to North America, and introduced in parts of Europe, Asia, and South America.

The muskrat is found in wetlands over a wide range of climates and habitats. It has important effects on the ecology of wetlands and is a resource of food and fur for humans.

Muskrats are found over most of Canada, where they mostly inhabit wetlands, areas in or near saline and freshwater wetlands, rivers, lakes, or ponds.

The muskrat is known to inhabit rivers in the area near Pembroke. Although there are no recorded sightings in the databases used to identify species of interest for the purposes of the ERA, with this local knowledge it is assumed that they are present within the scoped area in the Muskrat and Ottawa Rivers.

(Reference: <https://www.inaturalist.org/taxa/45763-Ondatra-zibethicus>)

Red Squirrel



The American red squirrel (*Tamiasciurus hudsonicus*) is one of three species of tree squirrel currently classified in the genus *Tamiasciurus*, known as the pine squirrel (the others are the Douglas squirrel, *T. douglasii* and Mearns's squirrel, *T. mearnsi*). American red squirrels are also referred to as pine squirrels, North American red squirrels, and chickarees.

They are medium-sized (200–250 g) diurnal mammals that defend a year-round exclusive territory. Unlike most other rodents, they are omnivorous and will eat insects and, sometimes, small birds and other mammals, although most often various seeds make up the majority of their diet.

The database for the area around the facility from iNaturalist.org notes sightings of Red Squirrels within the scoped area of the ERA.

(Reference: https://www.inaturalist.org/guide_taxa/263636)

Butternut Tree

Butternut is a medium-sized tree that can reach up to 30 m in height. It belongs to the walnut family and produces edible nuts in the fall. The bark of younger trees is grey and smooth, becoming ridged as the tree ages.

Butternut is easily recognized by its compound leaves, which are made up of 11 to 17 leaflets (each nine to 15 centimetres long) arranged in a feather-like pattern. The fruit is a large nut that contains a single seed surrounded by a light green, sticky, fuzzy husk.

Butternut can be found throughout central and eastern North America. In Canada, Butternut occurs in Ontario, Quebec and New Brunswick. It is classified as an endangered species.

The pagànàkominaganj (butternut tree) is not only a food source that the ancestors of the Anishinàbe Algonquin people consumed, but it was a medicine as well. The oil is extracted through heat from the butternut nut that contains the medicinal properties. It was also used to help keep bugs away.

The database for the area around the facility from iNaturalist.org notes a single, specific sighting of the Butternut within the scoped area of the ERA.

(Reference: <https://www.ontario.ca/page/butternut-species-risk>)

APPENDIX D

Exposure Values Table for EcoRA

LOCATION	MEDIA	VEC	UNITS	EMP 11-YR AVG.	EMP 11-YR MAX.	APPLIED VALUE FOR CONSERVATIVE CALCULATION	NOTES
Site Perimeter – Terrestrial Environment	Air	Earthworm Barn Swallow Blanding’s Turtle Ring-billed Gull Red Squirrel	Bq/m ³	2.17	24.40	49	Average value derived for all stations at 250 metres between 2015-2025. Max measured value obtained at NW250 in Nov. 2015; taken as conservative representation of terrestrial environment near facility after doubling.
	Soil	Butternut Tree Earthworm	Bq/kg (free-water tritium)	N/A (value of 50 estimated)	219	438	Measurement taken from those obtained in 2017 by University of Ottawa. Soil sampled was from electrical upgrade cable trench very near the facility. This value is taken as conservative representation of soil tritium concentration near facility after doubling.
	Water	Butternut Tree Earthworm Barn Swallow Blanding’s Turtle Ring-billed Gull Red Squirrel	Bq/L	82	1,621	3,242	Average and maximum measurements in precipitation between 2015-2025 at sampler 4P. Maximum measured value obtained in Nov. 2015; taken as conservative representation of available water intake concentration for terrestrial environment near facility after doubling

LOCATION	MEDIA	VEC	UNITS	EMP 11-YR AVG.	EMP 11-YR MAX.	APPLIED VALUE FOR CONSERVATIVE CALCULATION	NOTES
Muskrat River – Riparian Zone	Air	Muskrat Blanding’s Turtle Ring-billed Gull Earthworm	Bq/m ³	3.05	12.03	25	Average measured value from EMP PAS SE250 between 2015-2025. This station is nearest the Muskrat River / Boundary Road bridge area. Max measured value obtained at SE250 in Jan. 2021; taken as conservative representation of riparian environment near facility after doubling.
	Soil	Earthworm	Bq/kg (free-water tritium)	N/A	219	219	Soil measurements not available near this zone; as such, as a conservative treatment of the data, the soil concentrations near the facility will be applied, but not doubled.
	Water	Muskrat Blanding’s Turtle Ring-billed Gull Earthworm	Bq/L	76	875	1,750	Average measured value from sampler 18P between 2015-2025. This station is nearest the Muskrat River / Boundary Road bridge area. Max measured value obtained at 18P in Nov. 2015; taken as conservative representation of riparian environment near facility after doubling.
	Bulrushes	Muskrat Ring-billed Gull	Bq/kg	254	3,225	6,450	Data from sampling and measurements of riparian and aquatic plants during new Special Annual Sampling Campaign. Maximum value of 3,225 Bq/kg obtained in 2024; taken as conservative representation of riparian environment near facility after doubling.

LOCATION	MEDIA	VEC	UNITS	EMP 11-YR AVG.	EMP 11-YR MAX.	APPLIED VALUE FOR CONSERVATIVE CALCULATION	NOTES
Muskrat River – Benthic / Pelagic Zone	Sediment	Benthic Invertebrates	Bq/kg (free-water tritium)	22	52	104	<p>Data from sediment sampling and measurements of the Muskrat River during new Special Annual Sampling Campaign.</p> <p>Maximum value of 52 Bq/kg obtained in 2022; taken as conservative representation of benthic / pelagic environment near facility after doubling.</p>
	Water	American Eel Blanding's Turtle Lake Sturgeon Muskrat Benthic Invertebrates	Bq/L	5	14	28	<p>Data from Muskrat River water sampling and measurements during new Special Annual Sampling Campaign.</p> <p>Maximum value of 14 Bq/L obtained in 2023; taken as conservative representation of benthic / pelagic environment near facility after doubling.</p>

APPENDIX E**VEC Pathway Dose Calculations**

$$\Sigma \text{ Dose Rate} = \Sigma (\text{Media Concentration} \times \text{Bioaccumulation or Transfer Factor} \times \text{Diet Factor} \times \text{Dose Coefficient})$$

Application of a specific-activity model for tritium exposure to VEC, as well as the pertinent bioaccumulation / transfer / diet factors leads to the following conservative dose rates for each type of VEC (Table E1), in $\mu\text{Gy/h}$.

Dose rates calculated on the basis of more probable levels of exposure are also included for comparison (Table E2).

Note: bioaccumulation factors are expressed either in units of m^3/kg fresh weight (for transfer from air), or L/kg fresh weight (for transfer from water).

Table E1: Conservatively Characterized VEC Dose Rates

Benthic Invertebrates		Media Concentration (Bq/kg, Bq/L, Bq/m3)	Bioaccumulation Factor or Transfer Factor	Tissue Concentration (Bq/kg fw)	Dose Coefficient (μGy/h per Bq/kg)	OBT Factor	Dose Rate (μGy/h)	Population-Level Benchmark Dose Rate (μGy/h)	% of Population Benchmark Rate	Individual Organism Benchmark Dose Rate (μGy/day)	% of Individual Benchmark Rate
Exposure Pathway	Variable										
Sediment Immersion	P(BI_SED)	104	0.75	78.00	3.30E-06	1.5	3.86E-04	100	0.000%	1000	0.001%
Water Immersion	P(BI_WI)	28	0.75	21.00	3.30E-06	1.5	1.04E-04	100	0.000%	1000	0.000%
SUM OF DOSE RATES							4.90E-04	100	0.000%	1000	0.001%
Bulrushes		Media Concentration (Bq/kg, Bq/L, Bq/m3)	Bioaccumulation Factor or Transfer Factor	Tissue Concentration (Bq/kg fw)	Dose Coefficient (μGy/h per Bq/kg)	OBT Factor	Dose Rate (μGy/h)	Population-Level Benchmark Dose Rate (μGy/h)	% of Population Benchmark Rate	Individual Organism Benchmark Dose Rate (μGy/day)	% of Individual Benchmark Rate
Exposure Pathway	Variable										
Water Immersion	P(BR_WI)			6,450.00	3.30E-06	1.5	3.19E-02	100	0.032%	1000	0.077%
SUM OF DOSE RATES							3.19E-02	100	0.032%	1000	0.077%
Butternut		Media Concentration (Bq/kg, Bq/L, Bq/m3)	Bioaccumulation Factor or Transfer Factor	Tissue Concentration (Bq/kg fw)	Dose Coefficient (μGy/h per Bq/kg)	OBT Factor	Dose Rate (μGy/h)	Population-Level Benchmark Dose Rate (μGy/h)	% of Population Benchmark Rate	Individual Organism Benchmark Dose Rate (μGy/day)	% of Individual Benchmark Rate
Exposure Pathway	Variable										
Water Intake	P(BR_WI)	3,242	3.85	12,481.70	3.30E-06	1.5	6.18E-02	100	0.062%	1000	0.148%
SUM OF DOSE RATES							6.18E-02	100	0.062%	1000	0.148%
Earthworms - Riparian		Media Concentration (Bq/kg, Bq/L, Bq/m3)	Bioaccumulation Factor or Transfer Factor	Tissue Concentration (Bq/kg fw)	Dose Coefficient (μGy/h per Bq/kg)	OBT Factor	Dose Rate (μGy/h)	Population-Level Benchmark Dose Rate (μGy/h)	% of Population Benchmark Rate	Individual Organism Benchmark Dose Rate (μGy/day)	% of Individual Benchmark Rate
Exposure Pathway	Variable										
Soil Intake	P(EWR_SOIL)	219	150.00	32,850.00	3.30E-06	1.5	1.63E-01	100	0.163%	1000	0.390%
Air Intake	P(EWR_AIR)	25	1.40	35.00	3.30E-06	1.5	1.73E-04	100	0.000%	1000	0.000%
Water Immersion	P(EWR_WI)	1,750	150.00	262,500.00	3.30E-06	1.5	1.30E+00	100	1.299%	1000	3.119%
SUM OF DOSE RATES							1.46E+00	100	1.462%	1000	3.509%
Earthworms - Terrestrial		Media Concentration (Bq/kg, Bq/L, Bq/m3)	Bioaccumulation Factor or Transfer Factor	Tissue Concentration (Bq/kg fw)	Dose Coefficient (μGy/h per Bq/kg)	OBT Factor	Dose Rate (μGy/h)	Population-Level Benchmark Dose Rate (μGy/h)	% of Population Benchmark Rate	Individual Organism Benchmark Dose Rate (μGy/day)	% of Individual Benchmark Rate
Exposure Pathway	Variable										
Soil Intake	P(EWT_SOIL)	438	150.00	65,700.00	3.30E-06	1.5	3.25E-01	100	0.325%	1000	0.781%
Air Intake	P(EWT_AIR)	49	1.40	68.60	3.30E-06	1.5	3.40E-04	100	0.000%	1000	0.001%
Water Intake	P(EWT_WI)	3,242	150.00	486,300.00	3.30E-06	1.5	2.41E+00	100	2.407%	1000	5.777%
SUM OF DOSE RATES							2.73E+00	100	2.733%	1000	6.559%
Lake Sturgeon		Media Concentration (Bq/kg, Bq/L, Bq/m3)	Bioaccumulation Factor or Transfer Factor	Tissue Concentration (Bq/kg fw)	Dose Coefficient (μGy/h per Bq/kg)	OBT Factor	Dose Rate (μGy/h)	Population-Level Benchmark Dose Rate (μGy/h)	% of Population Benchmark Rate	Individual Organism Benchmark Dose Rate (μGy/day)	% of Individual Benchmark Rate
Exposure Pathway	Variable										
Ingestion of Benthic Invertebrates	P(LS_BI)	99	0.54	53.46	3.30E-06	1.5	2.65E-04	100	0.000%	1000	0.001%
Water Immersion	P(LS_WI)	28	0.75	21.00	3.30E-06	1.5	1.04E-04	100	0.000%	1000	0.000%
SUM OF DOSE RATES							3.69E-04	100	0.000%	1000	0.001%
Blanding's Turtle (Riparian)		Media Concentration (Bq/kg, Bq/L, Bq/m3)	Bioaccumulation Factor or Transfer Factor	Tissue Concentration (Bq/kg fw)	Dose Coefficient (μGy/h per Bq/kg)	OBT Factor	Dose Rate (μGy/h)	Population-Level Benchmark Dose Rate (μGy/h)	% of Population Benchmark Rate	Individual Organism Benchmark Dose Rate (μGy/day)	% of Individual Benchmark Rate
Exposure Pathway	Variable										
Ingestion of Benthic Invertebrates	P(BTR_BI)	99	0.54	53.46	3.30E-06	1.5	2.65E-04	100	0.000%	1000	0.001%
Air Intake	P(BTR_AIR)	25	1.40	35.00	3.30E-06	1.5	1.73E-04	100	0.000%	1000	0.000%
Water Intake	P(BTR_WI)	1,750	0.35	612.50	3.30E-06	1.5	3.03E-03	100	0.003%	1000	0.007%
SUM OF DOSE RATES							3.47E-03	100	0.003%	1000	0.008%
Blanding's Turtle (Terrestrial)		Media Concentration (Bq/kg, Bq/L, Bq/m3)	Bioaccumulation Factor or Transfer Factor	Tissue Concentration (Bq/kg fw)	Dose Coefficient (μGy/h per Bq/kg)	OBT Factor	Dose Rate (μGy/h)	Population-Level Benchmark Dose Rate (μGy/h)	% of Population Benchmark Rate	Individual Organism Benchmark Dose Rate (μGy/day)	% of Individual Benchmark Rate
Exposure Pathway	Variable										
Ingestion of Benthic Invertebrates	P(BTT_BI)	99	0.54	53.46	3.30E-06	1.5	2.65E-04	100	0.000%	1000	0.001%
Air Intake	P(BTT_AIR)	49	1.40	68.60	3.30E-06	1.5	3.40E-04	100	0.000%	1000	0.001%
Water Intake	P(BTT_WI)	3,242	0.35	1,134.70	3.30E-06	1.5	5.62E-03	100	0.006%	1000	0.013%
SUM OF DOSE RATES							6.22E-03	100	0.006%	1000	0.015%

Muskrat (Riparian)		Media Concentration (Bq/kg, Bq/L, Bq/m3)	Bioaccumulation Factor or Transfer Factor	Fraction of dietary intake	Tissue Concentration (Bq/kg fw)	Dose Coefficient (µGy/h per Bq/kg)	OBT Factor	Dose Rate (µGy/h)	Population-Level Benchmark Dose Rate (µGy/h)	% of Population Benchmark Rate	Individual Organism Benchmark Dose Rate (µGy/day)	% of Individual Benchmark Rate
Exposure Pathway	Variable											
Ingestion of Benthic Invertebrates	P(MRR_BI)	99	0.54	0.05	2.67	3.30E-06	1.5	1.32E-05	100	0.000%	1000	0.000%
Ingestion of Bulrushes	P(MRR_BR)	6,450	0.54	0.95	3,308.85	3.30E-06	1.5	1.64E-02	100	0.016%	1000	0.039%
Air Intake	P(MRR_AIR)	25	1.40		35.00	3.30E-06	1.5	1.73E-04	100	0.000%	1000	0.000%
Water Intake	P(MRR_WI)	1,750	0.35		612.50	3.30E-06	1.5	3.03E-03	100	0.003%	1000	0.007%
SUM OF DOSE RATES								1.96E-02	100	0.020%	1000	0.047%
Muskrat (Terrestrial)		Media Concentration (Bq/kg, Bq/L, Bq/m3)	Bioaccumulation Factor or Transfer Factor	Fraction of dietary intake	Tissue Concentration (Bq/kg fw)	Dose Coefficient (µGy/h per Bq/kg)	OBT Factor	Dose Rate (µGy/h)	Population-Level Benchmark Dose Rate (µGy/h)	% of Population Benchmark Rate	Individual Organism Benchmark Dose Rate (µGy/day)	% of Individual Benchmark Rate
Exposure Pathway	Variable											
Ingestion of Benthic Invertebrates	P(MRT_BI)	99	0.54	0.05	2.67	3.30E-06	1.5	1.32E-05	100	0.000%	1000	0.000%
Ingestion of Bulrushes	P(MRT_BR)	6,450	0.54	0.95	3,308.85	3.30E-06	1.5	1.64E-02	100	0.016%	1000	0.039%
Air Intake	P(MRT_AIR)	49	1.40		68.60	3.30E-06	1.5	3.40E-04	100	0.000%	1000	0.001%
Water Intake	P(MRT_WI)	3,242	0.35		1,134.70	3.30E-06	1.5	5.62E-03	100	0.006%	1000	0.013%
SUM OF DOSE RATES								2.23E-02	100	0.022%	1000	0.054%
Barn Swallow (Terrestrial)		Media Concentration (Bq/kg, Bq/L, Bq/m3)	Bioaccumulation Factor or Transfer Factor	Tissue Concentration (Bq/kg fw)	Dose Coefficient (µGy/h per Bq/kg)	OBT Factor	Dose Rate (µGy/h)	Population-Level Benchmark Dose Rate (µGy/h)	% of Population Benchmark Rate	Individual Organism Benchmark Dose Rate (µGy/day)	% of Individual Benchmark Rate	
Exposure Pathway	Variable											
Ingestion of Benthic Invertebrates	P(BS_BI)	99	0.54	53.46	3.30E-06	1.5	2.65E-04	100	0.000%	1000	0.001%	
Air Intake	P(BS_AIR)	49	1.40	68.60	3.30E-06	1.5	3.40E-04	100	0.000%	1000	0.001%	
Water Intake	P(BS_WI)	3,242	0.35	1,134.70	3.30E-06	1.5	5.62E-03	100	0.006%	1000	0.013%	
SUM OF DOSE RATES								6.22E-03	100	0.006%	1000	0.015%
Red Squirrel (Terrestrial)		Media Concentration (Bq/kg, Bq/L, Bq/m3)	Bioaccumulation Factor or Transfer Factor	Tissue Concentration (Bq/kg fw)	Dose Coefficient (µGy/h per Bq/kg)	OBT Factor	Dose Rate (µGy/h)	Population-Level Benchmark Dose Rate (µGy/h)	% of Population Benchmark Rate	Individual Organism Benchmark Dose Rate (µGy/day)	% of Individual Benchmark Rate	
Exposure Pathway	Variable											
Ingestion of Butternut	P(RS_BN)	12,482	0.54	6,740.28	3.30E-06	1.5	3.34E-02	100	0.033%	1000	0.080%	
Air Intake	P(RS_AIR)	49	1.40	68.60	3.30E-06	1.5	3.40E-04	100	0.000%	1000	0.001%	
Water Intake	P(RS_WI)	3,242	0.35	1,134.70	3.30E-06	1.5	5.62E-03	100	0.006%	1000	0.013%	
SUM OF DOSE RATES								3.93E-02	100	0.039%	1000	0.094%
Ring-billed Gull (Terrestrial)		Media Concentration (Bq/kg, Bq/L, Bq/m3)	Bioacc./Transfer Factor (unitless)	Fraction of dietary intake	Tissue Concentration (Bq/kg fw)	Dose Coefficient (µGy/h per Bq/kg)	OBT Factor	Dose Rate (µGy/h)	Population-Level Benchmark Dose Rate (µGy/h)	% of Population Benchmark Rate	Individual Organism Benchmark Dose Rate (µGy/day)	% of Individual Benchmark Rate
Exposure Pathway	Variable											
Ingestion of Benthic Invertebrates	P(RBG_BI)	99	0.54	0.20	10.69	3.30E-06	1.5	5.29E-05	100	0.000%	1000	0.000%
Ingestion of Bulrushes	P(RBG_BR)	6,450	0.54	0.20	696.60	3.30E-06	1.5	3.45E-03	100	0.003%	1000	0.008%
Ingestion of Earthworms	P(RBG_EW)	552,069	0.54	0.20	59,623.45	3.30E-06	1.5	2.95E-01	100	0.295%	1000	0.708%
Ingestion of Lake Sturgeon	P(RBG_LS)	75	0.54	0.20	8.10	3.30E-06	1.5	4.01E-05	100	0.000%	1000	0.000%
Ingestion of Red Squirrel	P(RBG_RS)	7,944	0.54	0.20	857.95	3.30E-06	1.5	4.25E-03	100	0.004%	1000	0.010%
Air Intake	P(RBG_AIR)	49	1.40		68.60	3.30E-06	1.5	3.40E-04	100	0.000%	1000	0.001%
Water Intake	P(RBG_WI)	3,242	0.35		1,134.70	3.30E-06	1.5	5.62E-03	100	0.006%	1000	0.013%
SUM OF DOSE RATES								3.09E-01	100	0.309%	1000	0.741%

Table E2: Realistically Characterized VEC Dose Rates

Benthic Invertebrates		Media Concentration (Bq/kg, Bq/L, Bq/m3)	Bioaccumulation Factor or Transfer Factor	Tissue Concentration (Bq/kg fw)	Dose Coefficient (µGy/h per Bq/kg)	OBT Factor	Dose Rate (µGy/h)	Population-Level Benchmark Dose Rate (µGy/h)	% of Population Benchmark Rate	Individual Organism Benchmark Dose Rate (µGy/day)	% of Individual Benchmark Rate
Exposure Pathway	Variable										
Sediment Immersion	P(BI_SED)	22	0.75	16.50	3.30E-06	1.5	8.17E-05	100	0.000%	1000	0.000%
Water Immersion	P(BI_WI)	5	0.75	3.75	3.30E-06	1.5	1.86E-05	100	0.000%	1000	0.000%
SUM OF DOSE RATES							1.00E-04	100	0.000%	1000	0.000%
Bulrushes		Media Concentration (Bq/kg, Bq/L, Bq/m3)	Bioaccumulation Factor or Transfer Factor	Tissue Concentration (Bq/kg fw)	Dose Coefficient (µGy/h per Bq/kg)	OBT Factor	Dose Rate (µGy/h)	Population-Level Benchmark Dose Rate (µGy/h)	% of Population Benchmark Rate	Individual Organism Benchmark Dose Rate (µGy/day)	% of Individual Benchmark Rate
Exposure Pathway	Variable										
Water Immersion	P(BR_WI)			254.00	3.30E-06	1.5	1.26E-03	100	0.001%	1000	0.003%
SUM OF DOSE RATES							1.26E-03	100	0.001%	1000	0.003%
Butternut		Media Concentration (Bq/kg, Bq/L, Bq/m3)	Bioaccumulation Factor or Transfer Factor	Tissue Concentration (Bq/kg fw)	Dose Coefficient (µGy/h per Bq/kg)	OBT Factor	Dose Rate (µGy/h)	Population-Level Benchmark Dose Rate (µGy/h)	% of Population Benchmark Rate	Individual Organism Benchmark Dose Rate (µGy/day)	% of Individual Benchmark Rate
Exposure Pathway	Variable										
Water Intake	P(BR_WI)	82	3.85	315.70	3.30E-06	1.5	1.56E-03	100	0.002%	1000	0.004%
SUM OF DOSE RATES							1.56E-03	100	0.002%	1000	0.004%
Earthworms - Riparian		Media Concentration (Bq/kg, Bq/L, Bq/m3)	Bioaccumulation Factor or Transfer Factor	Tissue Concentration (Bq/kg fw)	Dose Coefficient (µGy/h per Bq/kg)	OBT Factor	Dose Rate (µGy/h)	Population-Level Benchmark Dose Rate (µGy/h)	% of Population Benchmark Rate	Individual Organism Benchmark Dose Rate (µGy/day)	% of Individual Benchmark Rate
Exposure Pathway	Variable										
Soil Intake	P(EWR_SOIL)	50	150.00	7,500.00	3.30E-06	1.5	3.71E-02	100	0.037%	1000	0.089%
Air Intake	P(EWR_AIR)	3	1.40	4.20	3.30E-06	1.5	2.08E-05	100	0.000%	1000	0.000%
Water Immersion	P(EWR_WI)	76	150.00	11,400.00	3.30E-06	1.5	5.64E-02	100	0.056%	1000	0.135%
SUM OF DOSE RATES							9.36E-02	100	0.094%	1000	0.225%
Earthworms - Terrestrial		Media Concentration (Bq/kg, Bq/L, Bq/m3)	Bioaccumulation Factor or Transfer Factor	Tissue Concentration (Bq/kg fw)	Dose Coefficient (µGy/h per Bq/kg)	OBT Factor	Dose Rate (µGy/h)	Population-Level Benchmark Dose Rate (µGy/h)	% of Population Benchmark Rate	Individual Organism Benchmark Dose Rate (µGy/day)	% of Individual Benchmark Rate
Exposure Pathway	Variable										
Soil Intake	P(EWT_SOIL)	50	150.00	7,500.00	3.30E-06	1.5	3.71E-02	100	0.037%	1000	0.089%
Air Intake	P(EWT_AIR)	2	1.40	2.80	3.30E-06	1.5	1.39E-05	100	0.000%	1000	0.000%
Water Intake	P(EWT_WI)	82	150.00	12,300.00	3.30E-06	1.5	6.09E-02	100	0.061%	1000	0.146%
SUM OF DOSE RATES							9.80E-02	100	0.098%	1000	0.235%
Lake Sturgeon		Media Concentration (Bq/kg, Bq/L, Bq/m3)	Bioaccumulation Factor or Transfer Factor	Tissue Concentration (Bq/kg fw)	Dose Coefficient (µGy/h per Bq/kg)	OBT Factor	Dose Rate (µGy/h)	Population-Level Benchmark Dose Rate (µGy/h)	% of Population Benchmark Rate	Individual Organism Benchmark Dose Rate (µGy/day)	% of Individual Benchmark Rate
Exposure Pathway	Variable										
Ingestion of Benthic Invertebrates	P(LS_BI)	21	0.54	11.34	3.30E-06	1.5	5.61E-05	100	0.000%	1000	0.000%
Water Immersion	P(LS_WI)	5	0.75	3.75	3.30E-06	1.5	1.86E-05	100	0.000%	1000	0.000%
SUM OF DOSE RATES							7.47E-05	100	0.000%	1000	0.000%
Blanding's Turtle (Riparian)		Media Concentration (Bq/kg, Bq/L, Bq/m3)	Bioaccumulation Factor or Transfer Factor	Tissue Concentration (Bq/kg fw)	Dose Coefficient (µGy/h per Bq/kg)	OBT Factor	Dose Rate (µGy/h)	Population-Level Benchmark Dose Rate (µGy/h)	% of Population Benchmark Rate	Individual Organism Benchmark Dose Rate (µGy/day)	% of Individual Benchmark Rate
Exposure Pathway	Variable										
Ingestion of Benthic Invertebrates	P(BTR_BI)	21	0.54	11.34	3.30E-06	1.5	5.61E-05	100	0.000%	1000	0.000%
Air Intake	P(BTR_AIR)	3	1.40	3.57	3.30E-06	1.5	1.77E-05	100	0.000%	1000	0.000%
Water Intake	P(BTR_WI)	76	0.35	26.60	3.30E-06	1.5	1.32E-04	100	0.000%	1000	0.000%
SUM OF DOSE RATES							2.05E-04	100	0.000%	1000	0.000%
Blanding's Turtle (Terrestrial)		Media Concentration (Bq/kg, Bq/L, Bq/m3)	Bioaccumulation Factor or Transfer Factor	Tissue Concentration (Bq/kg fw)	Dose Coefficient (µGy/h per Bq/kg)	OBT Factor	Dose Rate (µGy/h)	Population-Level Benchmark Dose Rate (µGy/h)	% of Population Benchmark Rate	Individual Organism Benchmark Dose Rate (µGy/day)	% of Individual Benchmark Rate
Exposure Pathway	Variable										
Ingestion of Benthic Invertebrates	P(BTT_BI)	21	0.54	11.34	3.30E-06	1.5	5.61E-05	100	0.000%	1000	0.000%
Air Intake	P(BTT_AIR)	2	1.40	3.43	3.30E-06	1.5	1.70E-05	100	0.000%	1000	0.000%
Water Intake	P(BTT_WI)	82	0.35	28.70	3.30E-06	1.5	1.42E-04	100	0.000%	1000	0.000%
SUM OF DOSE RATES							2.15E-04	100	0.000%	1000	0.001%

Muskrat (Riparian)		Media Concentration (Bq/kg, Bq/L, Bq/m3)	Bioaccumulation Factor or Transfer Factor	Fraction of dietary intake	Tissue Concentration (Bq/kg fw)	Dose Coefficient (μGy/h per Bq/kg)	OBT Factor	Dose Rate (μGy/h)	Population-Level Benchmark Dose Rate (μGy/h)	% of Population Benchmark Rate	Individual Organism Benchmark Dose Rate (μGy/day)	% of Individual Benchmark Rate
Exposure Pathway	Variable											
Ingestion of Benthic Invertebrates	P(MRR_BI)	21	0.54	0.05	0.57	3.30E-06	1.5	2.81E-06	100	0.000%	1000	0.000%
Ingestion of Bulrushes	P(MRR_BR)	254	0.54	0.95	130.30	3.30E-06	1.5	6.45E-04	100	0.001%	1000	0.002%
Air Intake	P(MRR_AIR)	3	1.40		3.57	3.30E-06	1.5	1.77E-05	100	0.000%	1000	0.000%
Water Intake	P(MRR_WI)	76	0.35		26.60	3.30E-06	1.5	1.32E-04	100	0.000%	1000	0.000%
SUM OF DOSE RATES								7.97E-04	100	0.001%	1000	0.002%
Muskrat (Terrestrial)		Media Concentration (Bq/kg, Bq/L, Bq/m3)	Bioaccumulation Factor or Transfer Factor	Fraction of dietary intake	Tissue Concentration (Bq/kg fw)	Dose Coefficient (μGy/h per Bq/kg)	OBT Factor	Dose Rate (μGy/h)	Population-Level Benchmark Dose Rate (μGy/h)	% of Population Benchmark Rate	Individual Organism Benchmark Dose Rate (μGy/day)	% of Individual Benchmark Rate
Exposure Pathway	Variable											
Ingestion of Benthic Invertebrates	P(MRT_BI)	21	0.54	0.05	0.57	3.30E-06	1.5	2.81E-06	100	0.000%	1000	0.000%
Ingestion of Bulrushes	P(MRT_BR)	254	0.54	0.95	130.30	3.30E-06	1.5	6.45E-04	100	0.001%	1000	0.002%
Air Intake	P(MRT_AIR)	2	1.40		3.43	3.30E-06	1.5	1.70E-05	100	0.000%	1000	0.000%
Water Intake	P(MRT_WI)	82	0.35		28.70	3.30E-06	1.5	1.42E-04	100	0.000%	1000	0.000%
SUM OF DOSE RATES								8.07E-04	100	0.001%	1000	0.002%
Barn Swallow (Terrestrial)		Media Concentration (Bq/kg, Bq/L, Bq/m3)	Bioaccumulation Factor or Transfer Factor	Tissue Concentration (Bq/kg fw)	Dose Coefficient (μGy/h per Bq/kg)	OBT Factor	Dose Rate (μGy/h)	Population-Level Benchmark Dose Rate (μGy/h)	% of Population Benchmark Rate	Individual Organism Benchmark Dose Rate (μGy/day)	% of Individual Benchmark Rate	
Exposure Pathway	Variable											
Ingestion of Benthic Invertebrates	P(BS_BI)	21	0.54	11.34	3.30E-06	1.5	5.61E-05	100	0.000%	1000	0.000%	
Air Intake	P(BS_AIR)	2	1.40	3.43	3.30E-06	1.5	1.70E-05	100	0.000%	1000	0.000%	
Water Intake	P(BS_WI)	82	0.35	28.70	3.30E-06	1.5	1.42E-04	100	0.000%	1000	0.000%	
SUM OF DOSE RATES								2.15E-04	100	0.000%	1000	0.001%
Red Squirrel (Terrestrial)		Media Concentration (Bq/kg, Bq/L, Bq/m3)	Bioaccumulation Factor or Transfer Factor	Tissue Concentration (Bq/kg fw)	Dose Coefficient (μGy/h per Bq/kg)	OBT Factor	Dose Rate (μGy/h)	Population-Level Benchmark Dose Rate (μGy/h)	% of Population Benchmark Rate	Individual Organism Benchmark Dose Rate (μGy/day)	% of Individual Benchmark Rate	
Exposure Pathway	Variable											
Ingestion of Butternut	P(RS_BN)	316	0.54	170.64	3.30E-06	1.5	8.45E-04	100	0.001%	1000	0.002%	
Air Intake	P(RS_AIR)	2	1.40	3.43	3.30E-06	1.5	1.70E-05	100	0.000%	1000	0.000%	
Water Intake	P(RS_WI)	82	0.35	28.70	3.30E-06	1.5	1.42E-04	100	0.000%	1000	0.000%	
SUM OF DOSE RATES								1.00E-03	100	0.001%	1000	0.002%
Ring-billed Gull (Terrestrial)		Media Concentration (Bq/kg, Bq/L, Bq/m3)	Bioacc./Transfer Factor (unitless)	Fraction of dietary intake	Tissue Concentration (Bq/kg fw)	Dose Coefficient (μGy/h per Bq/kg)	OBT Factor	Dose Rate (μGy/h)	Population-Level Benchmark Dose Rate (μGy/h)	% of Population Benchmark Rate	Individual Organism Benchmark Dose Rate (μGy/day)	% of Individual Benchmark Rate
Exposure Pathway	Variable											
Ingestion of Benthic Invertebrates	P(RBG_BI)	21	0.54	0.20	2.27	3.30E-06	1.5	1.12E-05	100	0.000%	1000	0.000%
Ingestion of Bulrushes	P(RBG_BR)	254	0.54	0.20	27.43	3.30E-06	1.5	1.36E-04	100	0.000%	1000	0.000%
Ingestion of Earthworms	P(RBG_EW)	19,803	0.54	0.20	2,138.72	3.30E-06	1.5	1.06E-02	100	0.011%	1000	0.025%
Ingestion of Lake Sturgeon	P(RBG_LS)	16	0.54	0.20	1.73	3.30E-06	1.5	8.55E-06	100	0.000%	1000	0.000%
Ingestion of Red Squirrel	P(RBG_RS)	203	0.54	0.20	21.92	3.30E-06	1.5	1.09E-04	100	0.000%	1000	0.000%
Air Intake	P(RBG_AIR)	2	1.40		3.43	3.30E-06	1.5	1.70E-05	100	0.000%	1000	0.000%
Water Intake	P(RBG_WI)	82	0.35		28.70	3.30E-06	1.5	1.42E-04	100	0.000%	1000	0.000%
SUM OF DOSE RATES								1.10E-02	100	0.011%	1000	0.026%